

2008

990 SUPER DUKE

990 SUPER DUKE R

ART. NR. 3.211.249 EN



KTM

We would like to congratulate you on your purchase of a KTM motorcycle. You are now the owner of a state-of-the-art sport motorcycle that guarantees to bring you lots of fun and enjoyment, provided that you clean and maintain it appropriately. Please insert the serial numbers of your motorcycle in the boxes below:

Frame number

Stamp of dealer

Engine number

Key number

All information contained is without obligation. KTM-Sportmotorcycle AG particularly reserves the right to modify any equipment, technical specifications, prices, colors, shapes, materials, services, service work, constructions, equipment and the like so as to adapt them to local conditions or to cancel any of the above items, all without previous announcement and without giving reasons. KTM may stop manufacturing certain models without previous notice. KTM shall not be held liable for any deviations of availability and/or ability to deliver, illustrations, descriptions, printing and/or other errors. The illustrated models partly contain extra equipment, which is not applied to standard models.

© 2007 by KTM-SPORTMOTORCYCLE AG, Mattighofen AUSTRIA; All rights reserved; Reprint, also in extracts, with written allowance of KTM-SPORTMOTORCYCLE AG, Mattighofen only.

CONSUMER INFORMATION FOR AUSTRALIA ONLY **Tampering with noise control system prohibited** Owners are warned that the law may prohibit:

- (a) The removal or rendering inoperative by any person other than for purposes of maintenance, repair or replacement, of any device or element of design incorporated into any new vehicle for the purpose of noise control prior to its sale or delivery to the ultimate purchaser or while it is in use; and
- (b) the use of the vehicle after such device or element of design has been removed or rendered inoperative by any person.



In accordance with the international quality management ISO 9001 standard, KTM uses quality assurance processes that lead to the highest possible product quality.

INTENDED PURPOSE

The 990 Super Duke is designed to resist the usual wear and tear of paved roads but is not designed for race courses or off-road use.

The 990 Super Duke R is designed to resist the usual wear and tear of paved roads or race courses but is not designed for off-road use.

OWNER'S MANUAL

Carefully read the entire Owner's Manual before you start riding your motorcycle, even if this will take a little time. It contains useful tips and information on the best way to handle the motorcycle and how to protect yourself from injuries. The Manual also contains important information on service and maintenance. In your own interest, pay particular attention to the information marked as follows:



WARNING

- Ignoring these instructions, can endanger your body and your life.



CAUTION

- Ignoring these instructions could cause damage to parts of your motorcycle or that the motor-cycle is not road-safe anymore.

The Owner's Manual corresponded to the latest information available for this model series at the time it was printed. Minor deviations resulting from enhancements to the motorcycle design cannot be entirely precluded. The Owner's Manual is an integral part of the motorcycle and must be handed over to the new owner when the motorcycle is sold.

SERVICE

Observance of the service, maintenance and operating instructions for the engine and chassis specified in the Owner's Manual is a prerequisite for faultless operation and the avoidance of premature wear. Please observe the prescribed breaking-in periods, inspection intervals and service intervals. Strict observance will significantly prolong the service life of your motorcycle.

The use of the motorcycle under extreme conditions, e.g. on the race course, can cause above average wear to components such as the brakes. In this case it may become necessary to service or replace wear parts before the service limit specified in the maintenance schedule has been reached.

WARRANTY

The service work specified in the „Lubrication and Maintenance Schedule“ must be performed by an authorized KTM workshop. This is the only place that has the qualified technicians and the special tools required for the 990 Super Duke / R. Be sure to have the workshop verify all service work carried out in the service manual to avoid losing your right to claim under the warranty. The warranty or guarantee shall become void for damage and consequential damage caused by manipulations or conversions to the motorcycle.

AUTOMOTIVE FLUIDS

The fuels, lubricants and liquids specified in the Owner's Manual or automotive fluids with equivalent specifications must be used in accordance with the maintenance schedule.

SPARE PARTS, ACCESSORIES

For your own safety, only use spare parts and accessories approved by KTM. KTM shall not assume any liability for other products or consequential damage resulting from the use of such products.

ENVIRONMENT

Motorcycle driving is a wonderful sport and we hope that you will be able to enjoy it to the full. It may, however, involve potential problems for the environment or lead to conflicts with others. These problems or conflicts can be avoided if the motorcycle is used responsibly. To safeguard the future of motorcycle sports, make sure that you use the motorcycle in accordance with the law, show that you are environmentally conscious and respect the rights of others.

Enjoy driving your motorcycle !

KTM SPORTMOTORCYCLE AG
5230 MATTIGHOFEN, AUSTRIA

INTRODUCTION	1	Damping action during compression of shock absorber . . .	20
IMPORTANT INFORMATION	2	Rebound damping of shock absorber	21
SERIAL NUMBER LOCATIONS	6	GENERAL TIPS AND WARNINGS FOR STARTING	
Chassis number, Type label	6	THE MOTORCYCLE	22
Engine number, engine type	6	Instructions for initial operation	22
OPERATION INSTRUMENTS	7	Running in the LC8 engine	22
Clutch lever	7	Accessories and payload	23
Hand brake lever	7	DRIVING INSTRUCTIONS	24
Combined instrument	8	Check the following before each start	24
Function buttons on combined instrument	8	Starting the engine	26
Combined instrument display	8	Starting off	27
Cooling liquid temperature display	12	Shifting/Riding	27
Tachometer	12	Braking	28
Indicator lamps	13	Stopping and parking	29
Ignition lock	14	Fuel	30
Combination switch	14	PERIODIC MAINTENANCE SCHEDULE	32
Starter tip switch, Emergency OFF tip switch	15	MAINTENANCE WORK ON CHASSIS AND ENGINE	36
Filler cap	15	Adjusting the fork and shock absorber	37
Seat lock, removing the seat	16	Adjusting compression damping of fork	37
Baggage loops	16	Adjusting rebound damping of fork	37
Tool set	17	Adjusting the spring preload on the fork	38
Helmet lock	17	Compression damping of shock absorber	38
Holding strap	17	Rebound damping of shock absorber	39
Shift lever	18	Checking the chain tension	40
Side stand	18	Correcting the chain tension	40
Foot brake pedal	18	Chain maintenance	41
Footrests	19	Checking the chain for wear	41
Compression damping of fork	19	General information on KTM disk brakes	42
Rebound damping of fork	19	Adjusting the basic position of the hand brake lever	44
Spring preload of the fork	20	Checking the front brake fluid level	44

Checking the front brake pads45	cleaning the oil screen68
Checking the rear brake fluid level46	TROUBLESHOOTING72
Checking the rear brake pads46	CLEANING77
Changing the seat height47	CONSERVATION FOR WINTER OPERATION77
Dismounting and remounting the front wheel48	STORAGE78
Dismounting and mounting the rear wheel50	STARTING UP AFTER IMMOBILIZATION78
Tires, air pressure51	TECHNICAL SPECIFICATIONS – CHASSIS79
Battery52	TECHNICAL SPECIFICATIONS – ENGINE84
Removing and remounting the battery53	Engine oil85
Charging the battery54	HEAD WORD INDEX86
Jump start54	CONSUMER INFORMATION FOR USA ONLY87
Main fuse55		
Fuses for individual power consumers56		
Replacing the headlight lamp57		
Adjusting the headlight range58		
Replacing the brake light and taillight bulbs59		
Replacing the flasher bulbs59		
Cooling system60		
Checking the cooling liquid level in the compensating tank61		
Checking the cooling liquid level in the radiator62		
Bleeding the cooling system62		
Changing the basic position of the clutch lever64		
Checking the oil level of the hydraulic clutch64		
Adjusting the handlebar tilt64		
How to change the handlebar position (Super Duke R)65		
Adjusting the steering damper (Super Duke R)65		
Engine oil66		
Checking the engine oil level66		
Refilling engine oil67		
Changing the engine oil and the oil filter,			

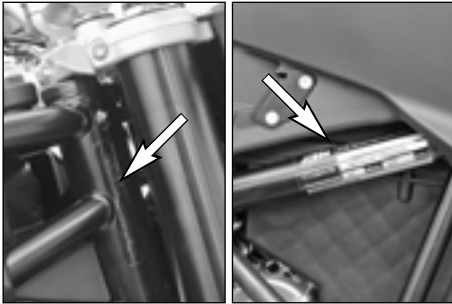

Chassis number, Type label

The chassis number is stamped on the right side of the steering head tube. Enter this number in the field on page no 1.

The type label is located on the right frame tube under the seat.

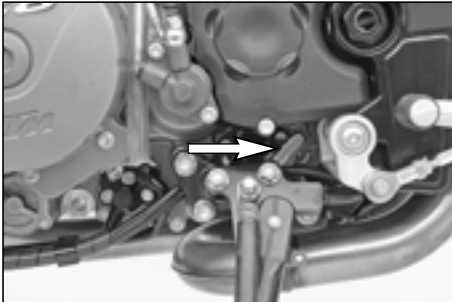

Engine number, engine type

The engine number and the engine type are stamped into the left side of the engine below the engine sprocket. Enter this number on page 1.

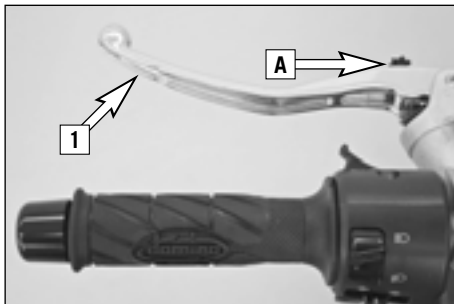

Clutch lever

The clutch lever [1] is fitted on the left hand side of the handle bar. The adjusting screw [A] is used to change the original position of the clutch lever (see maintenance work on chassis and engine).

The clutch is hydraulically actuated and adjusts itself automatically.

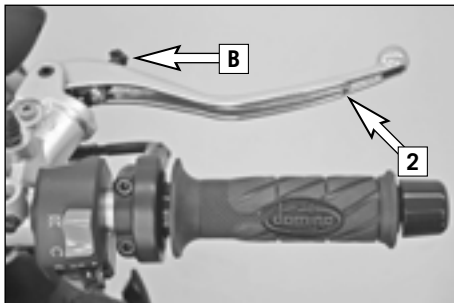

Hand brake lever

The hand brake lever [2] is mounted on the handlebar on the right and actuates the front wheel brake. The adjusting screw [B] is used to change the original position of the hand brake lever (see maintenance work on chassis and engine).



Combined instrument

The combined instrument is divided into 4 parts.

Function buttons: to select the display modes and basic settings in the display

Tachometer: displays the engine speed

Indicator lamps: provide additional information on the motorcycle operating condition

Display: shows the speed, cooling liquid temperature, time, ambient temperature, distance traveled (ODO), trip master 1 (TRIP 1), trip master 2 (TRIP 2), distance traveled since the reserve warning lamp went on (TRIP F)

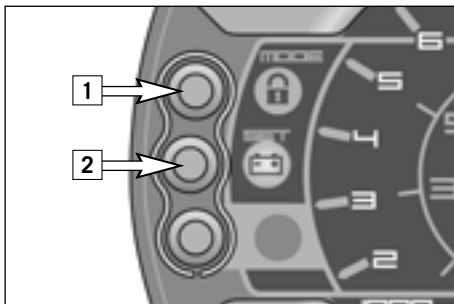

Function buttons on combined instrument

MODE [1]

Briefly press the MODE button to go to the next display mode. The available display modes are ambient temperature, distance traveled (ODO), trip master 1 (TRIP 1) and trip master 2 (TRIP 2).

The speed, cooling liquid temperature and time are always displayed.

SET [2]

Press the SET button to reset trip master 1 or 2 to 0.

The 3rd button is not programmed.

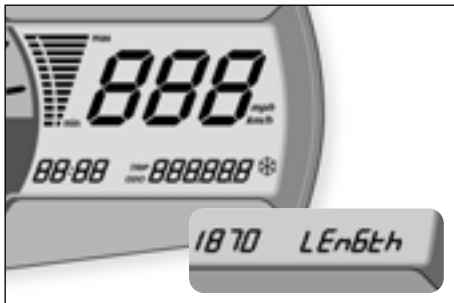

Combined instrument display

TEST

When you switch on the ignition, all of the display elements will light up for 1 second for the function test.

LENGTH

The display will change for 1 second to display the circumference of the front wheel in millimeters. 1870 mm corresponds to a 17" front wheel.

Then the display will change back to the mode that was activated when the ignition was switched off.

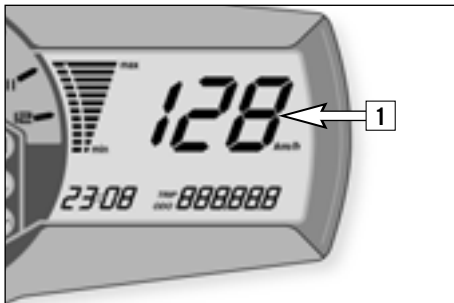

SPEED [1]

The speed can be displayed in kilometers per hour (km/h) or miles per hour (mph).

CHANGING THE SPEED DISPLAY FROM KM/H - MPH or MPH - KM/H

Switch on the ignition and press the MODE button more than 10 seconds in the ODO mode.

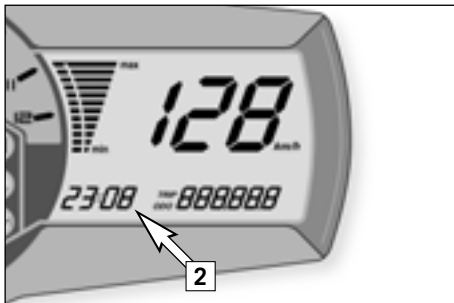

CLOCK [2]

The dots between the hours and minutes will blink in the CLOCK display.
The clock must be set if the battery was disconnected or if the fuse 7 was blown.

SETTING THE CLOCK

Switch on the ignition and select the ODO mode. Press and hold the MODE button while you press the SET button more than 1 second. The time will start to blink. Use the MODE button to set the hours. Use the SET button to set the minutes. Then press the MODE and SET buttons simultaneously.

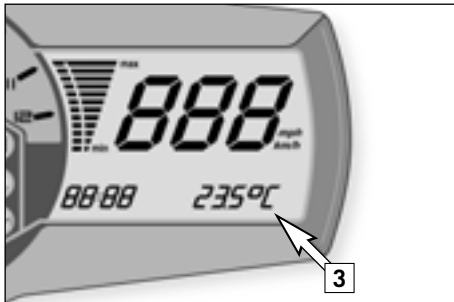

AMBIENT TEMPERATURE [3]

The ambient temperature can be displayed in Celsius (°C) or Fahrenheit (°F).

CHANGING THE AMBIENT TEMPERATURE DISPLAY FROM °C - °F or °F - °C

Switch on the ignition and press the MODE button more than 10 seconds in the ambient temperature mode.

Press the MODE button to go to the next display mode.

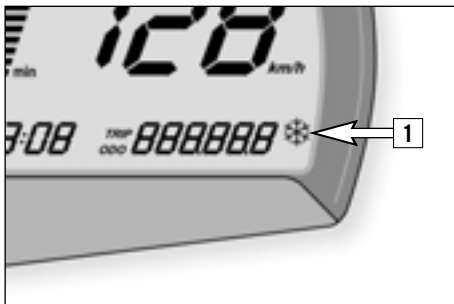

FROST WARNING [1]

The frost symbol will start to blink regardless of the mode if the ambient temperature drops below 3°C (37.5°F).

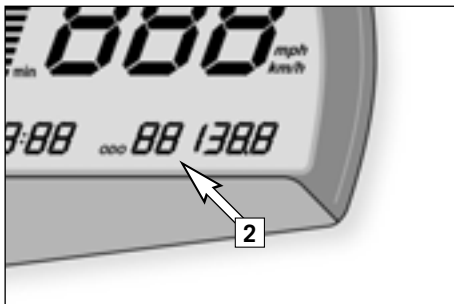

ODO [2]

Displays the total kilometers or miles traveled.
This figure will not be cleared if the battery is disconnected.

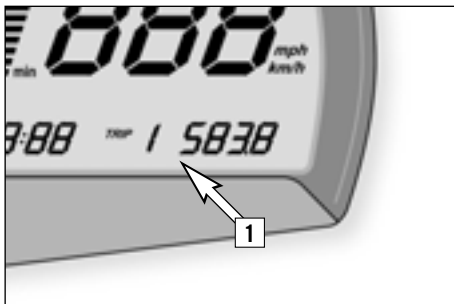

TRIP 1 [1]

The trip meter 1 is always active and counts up to 999.9. It is used to measure the length of the trip or the distance between 2 refueling stops.

TO RESET TRIP 1

To reset the trip meter 1 to zero, switch on the ignition, select the TRIP 1 display mode and press the SET button more than 2 seconds.

Press the MODE button to go to the next display mode.

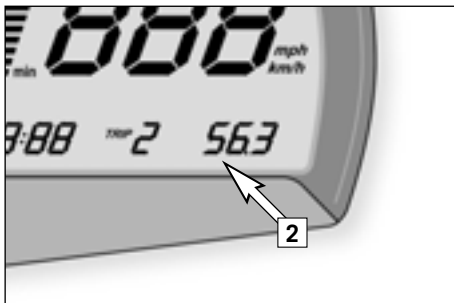

TRIP 2 [2]

The trip meter 2 is always active and counts up to 999.9. It is used just like TRIP 1.

TO RESET TRIP 2

To reset the trip meter 2 to zero, switch on the ignition, select the TRIP 2 display mode and press the SET button more than 2 seconds.

Press the MODE button to go to the next display mode.

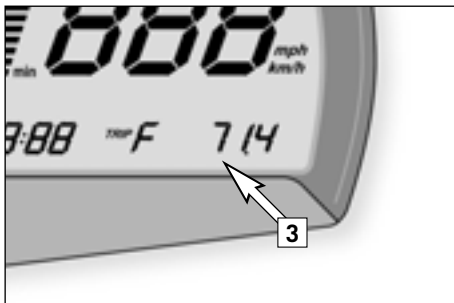

TRIP F [3]

When the fuel level reaches the reserve mark, the display will automatically switch to TRIP F and begin to count (no matter which display mode was active before). At the same time, the fuel warning lamp will light up. You will still have enough reserve fuel for at least 30 kilometers.

After refueling, it will take approx. 3 minutes for the fuel lamp to go out, TRIP F to automatically reset to 0 and to return to the previous display mode.

NOTE:

Press the SET button for 2 seconds to switch off the fuel warning lamp.



Cooling liquid temperature display

The temperature display [1] is shown in 12 bars. The more bars that light up, the hotter the cooling liquid. When the upper bar lights up 120°C (248°F), all of the bars will start to blink and the red warning lamp [2] will light up.

WARNING

Possible causes for an increase in temperature, causing the red warning light for the cooling liquid temperature to light up:

- Driving too slowly and driving with a heavy load at high air temperatures
- Not enough cooling liquid in the system
- The ventilator on the left radiator is not running
- Improper use of the clutch when driving slowly

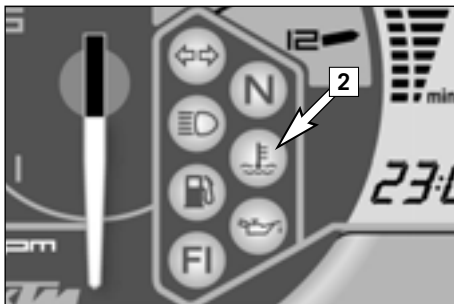

Tachometer

The tachometer [3] shows the engine speed in revolutions per minute. Do not run the engine beyond the orange mark.

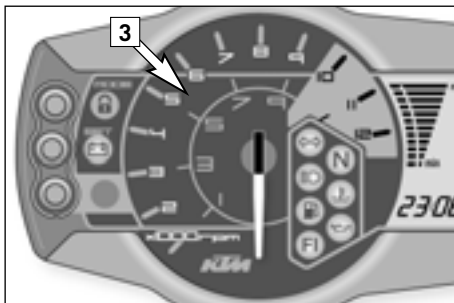





Indicator lamps

- 

The green indicator lamp will blink in the blinker rhythm when the blinker is switched on.
NOTE: The indicator lamp will blink faster when a blinker is broken.
- 

The green indicator lamp will light up when the gearbox is in an idling position.
- 

The blue indicator lamp will light up when the high beams are switched on.
- 

The red warning light will light up when the cooling liquid has reached a temperature of approx. 120°C (248°F).
- 

The orange warning lamp will light up when the fuel level has reached the reserve mark. At the same time the display will automatically change to TRIP F (see TRIP F).
- 

The red warning lamp lights up when the ignition is switched on but the engine is not running. When the engine is started, the warning lamp will go out as soon as the oil pressure is high enough.
- 



The orange warning lamp (fuel injection) briefly lights up when the ignition is switched on. It will go out when the gasoline pressure is high enough.
If this warning lamp lights up while driving, a component in the injection system is defective. The error can be identified by means of a blink code (see Trouble shooting).
- 





The red warning lamp will light up if the voltage in the on-board electrics drops below 10 volts. Immediately drive to the nearest authorized KTM workshop and have the electrical system checked.



Ignition lock

The ignition lock has 3 switching positions.

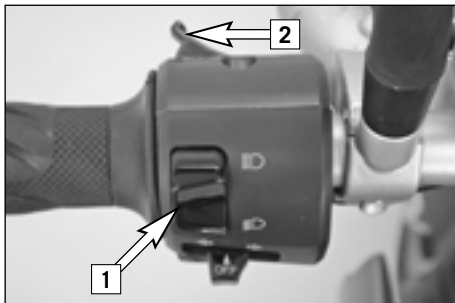

-  Ignition off, (engine can't be started)
-  Ignition on, (engine can be started)
-  Ignition off, handlebar blocked

To switch the ignition to position  turn the ignition key to position  and firmly press it into the lock. Turn the handlebar to the left, then turn the ignition key to the left. The ignition key can be withdrawn in position  and .





Combination switch

The rocker switch LIGHTS [1] actuates the high beam or low beam.

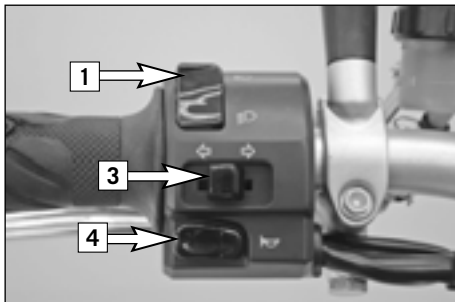
-  High-beam light
-  Low-beam light
-  The light signal (high beam) is actuated with button [2].



 The indicator switch [3] returns to central position after actuation. Press flasher switch towards switch housing to switch off the flasher.

 The horn is sounded with button [4].

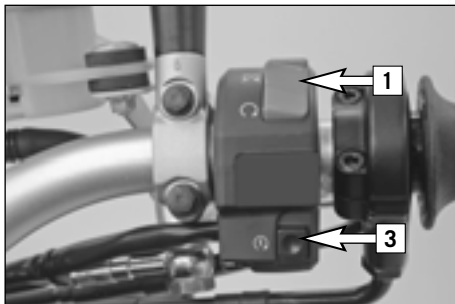

Starter tip switch, Emergency OFF tip switch

The emergency off switch [1] is provided for emergency situations and should not be used to switch off the engine.

The engine is ready for operation in position ○ (ignition circuit and starter circuit are switched on).

The engine cannot be started in position ☒ (ignition circuit and starter circuit are interrupted).



Use the starter tip switch [3] to operate the electric starter.

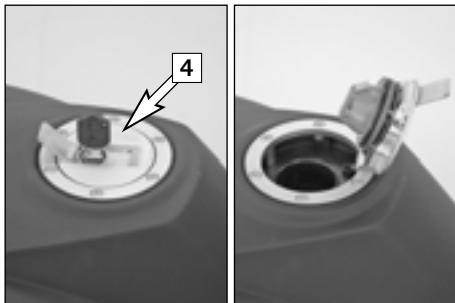

Filler cap

The filler cap [4] can be locked. It is equipped with a tank ventilation system.

To open, insert the ignition key, turn 45° in a clockwise direction and tilt the filler cap back.

After refueling, pull out the ignition key and press down on the filler cap until the lock engages.



Seat lock, removing the seat

The seat lock [1] can be locked with the ignition key.
To remove the seat, insert the ignition key and turn 90° in a clockwise direction. Lift the seat in the back while pressing near the holding strap and pull off towards the back.

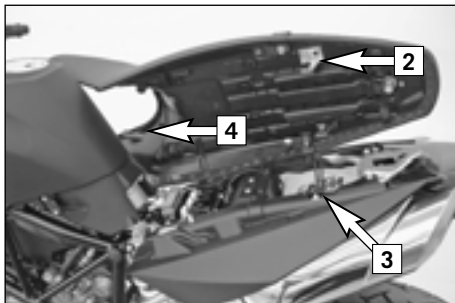

To mount the seat, place it on the motorcycle and position the hooks [2] on the bottom of the seat behind the dollies [3] on the subframe. Press down on the seat near the holding strap while sliding it forwards. The two tabs [4] must hook onto the tank. Turn the ignition key in the seat lock 90° in a counterclockwise direction and pull off. Check whether the seat is mounted correctly.

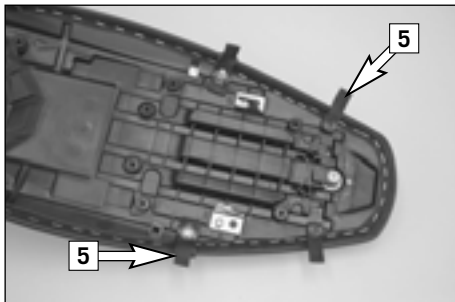

Baggage loops

4 loops [5] are mounted on the bottom of the seat to which small pieces of baggage can be fastened. Fold the loops towards the outside to make them accessible when the seat is mounted.

WARNING

Baggage weight: max. 5 kg

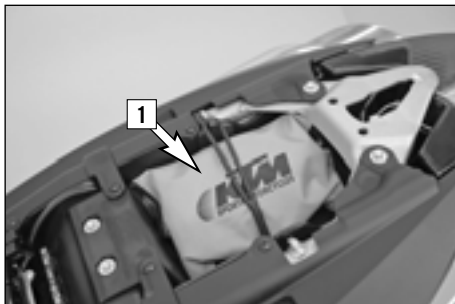

Tool set

The tool set [1] is located in the storage compartment under the seat.

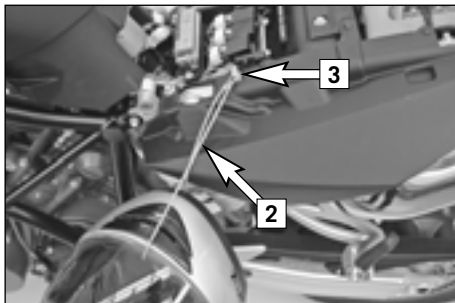

Helmet lock

The steel rope [2] in the tool bag can be used to secure a helmet.

To secure, remove the seat, run the rope through the helmet, attach both ends to the hook [3] and mount the seat.

WARNING

The helmet lock is provided to secure the helmet to the motorcycle when parked. Do not attach the helmet or other objects to the steel rope while driving. You can easily lose control of the motorcycle.



Holding strap

The passenger should hold on to the holding strap [4] or the driver while riding.

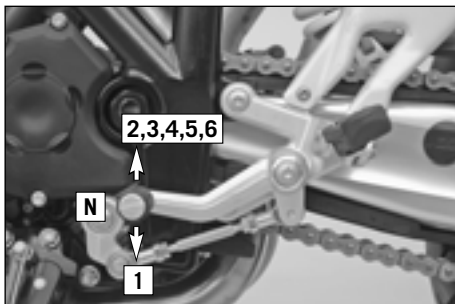

Shift lever

The shift lever is mounted on the left side of the engine. The position of the gears is shown in the illustration. Neutral, or the idle speed, is located between first and second gear. The basic position of the shift lever can be adjusted according to your seating position (see Maintenance work).

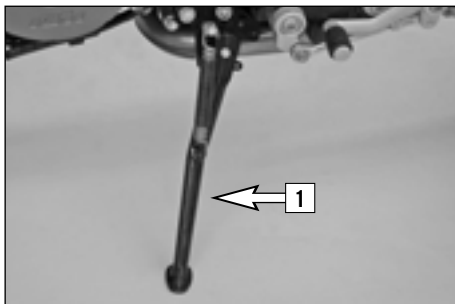

Side stand

Fold the side stand [1] forward to the stop with your foot and put the weight of the motorcycle on the stand. Make sure it is standing securely on a firm surface. The side stand is linked to the safety start system; follow the driving instructions.

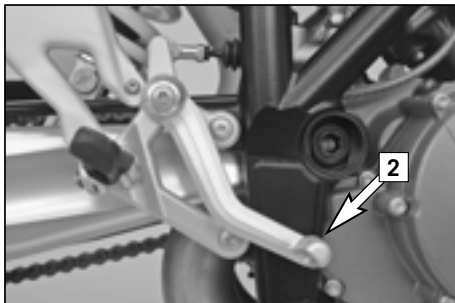

Foot brake pedal

The foot brake pedal [2] is located in front of the right footrest. Its basic position can be adjusted to your seat position.

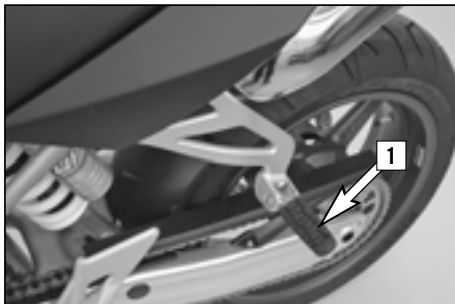

Footrests

The passenger footrests [1] fold up.

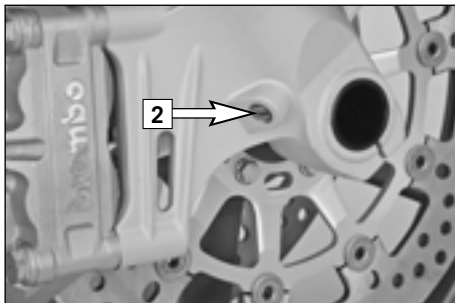

Compression damping of fork

The fork's damping action during compression travel (compression damping) can be adjusted. This allows you adjust the damping behavior to match your driving style and the payload. The adjusting screws [2] are located on the fork leg axle passage. More information is provided in the chapter „Adjusting the fork and shock absorber“.

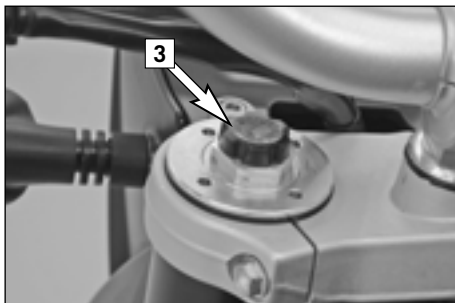

Rebound damping of fork

The fork's damping action during rebound travel (rebound damping) can also be adjusted. This allows you adjust the damping behavior to match your driving style and the payload. The adjusting screws [3] are located on the upper end of the fork legs. More information is provided in the chapter "Adjusting the fork and shock absorber."

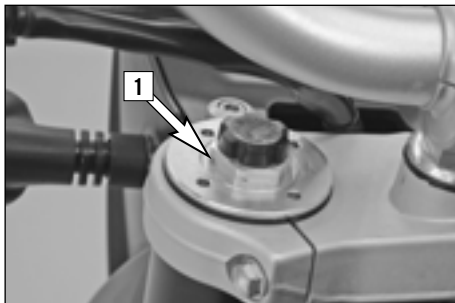

Spring preload of the fork

The fork's preload can be adjusted by means of the adjusting screws [1].
More information is provided in the chapter „Adjusting the fork and shock absorber“.

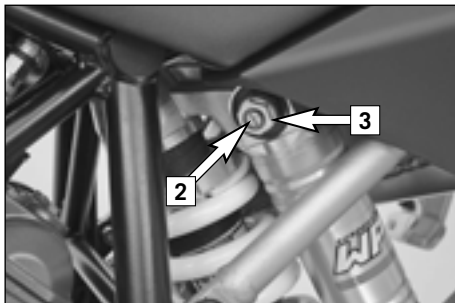

Damping action during compression of shock absorber

The shock absorber's damping action during compression travel (compression damping) can be adjusted. This allows you adjust the shock absorber's damping behavior to match your driving style and the payload.
The damping rate can be adjusted in the low and high-speed range (Dual Compression Control). The designation low and high-speed refers to the movement of the shock absorber and not to the motorcycle's driving speed.

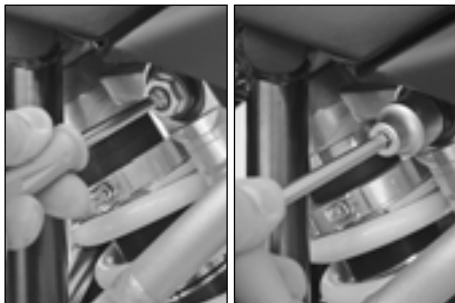

The adjusting screw [2] for the low-speed range can be adjusted with a screwdriver.

The adjusting screw [3] for the high-speed range can be adjusted with a 17 mm socket wrench.

More information is provided in the chapter „Adjusting the fork and shock absorber“.

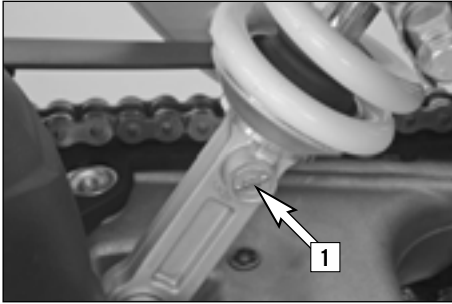

Rebound damping of shock absorber

The shock absorber's damping action during rebound travel (rebound damping) can also be adjusted. This allows you adjust the damping behavior to match your driving style and the payload.

The adjusting screw [1] is located on the bottom of the shock absorber.

More information is provided in the chapter "Adjusting the fork and shock absorber."

Instructions for initial operation

- Make sure the work for the „pre-delivery inspection“ was performed by your authorized KTM workshop. The DELIVERY CERTIFICATE and SERVICE MANUAL will be handed over when you pick up your vehicle.
- Read these operating instructions carefully before your first ride.
- Enter the chassis, engine and key numbers on page 1.
- Familiarize yourself with the operating elements.
- Adjust the clutch lever, the hand brake lever, the foot brake lever and the shift lever in the position that is most convenient for you.
- This motorcycle is equipped with a three-way catalytic converter. Leaded fuel will destroy the converter. Always use unleaded fuel.
- Get used to handling the motorcycle on an empty parking lot, before starting on a longer drive. Also try to drive as slowly as possible and in standing position, to improve your feeling for the vehicle.
- You may only be accompanied by a passenger if your motorcycle is fitted and registered for such purposes. The passenger must hold on to the supporting strap or the driver and keep his feet on the passenger footrests throughout the ride.
- Hold the handlebars with both hands and leave your feet on the foot rests while driving.

- Remove your foot from the foot brake lever when you are not braking. If the foot brake lever is not released the brake pads rub continuously and the braking system is overheated.
- Do not make any alterations to the motorcycle and always use ORIGINAL KTM SPARE PARTS. Spare parts from other manufacturers can impair the safety of the motorcycle.
- New tires have a smooth surface, which means that they must be run in to achieve full grip. For this purpose, ride the motorcycle carefully at moderate speed during the first 200 kilometers with new tires, tilting the vehicle at different angles so that all sections are properly roughened. Tires will not display their full grip characteristics until they are properly run in.
- Motorcycles are sensitive to changes in the weight distribution. Read the section on „Accessories and payload“ when carrying luggage.
- Pay attention to running-in procedure.

Running in the LC8 engine

Even finely machined surfaces of engine parts have rougher surfaces than parts that slide on each other for a long time. Therefore, every engine must be run in. For this reason, do not demand maximum performance from the engine for the first 1000 kilometers (620 miles). The vehicle must be run in at low, changing performance level for the first 1000

km (620 miles). The maximum number of revolutions per minute must not go exceed 6500 rpm. Once you have run your engine in for 1000 km, you may push it to its 9500 rpm limit , i.e. up to the orange zone indicated in the tachometer. Exceeding the above listed rotations as well as pushing high rpm when the engine is cold will have an adverse effect on the life of your engine.

WARNING

- **Wear suitable clothing when driving a motorcycle. Clever KTM drivers always wear a helmet, boots, gloves and a jacket, regardless of whether driving all day or just for a short trip. The protective clothing should be brightly colored so that other vehicle can see you as early as possible. Your passenger will also need suitable protective clothing.**
- **Do not drive after having consumed alcohol.**
- **Always turn on the light to make sure that other drivers become aware of you as early as possible.**
- **Drive at a moderate speed for the first few kilometers of each trip to allow the tires to reach the necessary operating temperature. Maximum road grip is assured when the tires are warm.**
- **The front and rear wheel are allowed to be fitted only with tires that have the same profile type.**

⚠ WARNING

- The tires must be designed for a speed of over 240 KPH (speed symbol ZR) and must be released by KTM.
- New tires have a smooth surface, which means that they must be run in to achieve full grip. For this purpose, ride the motorcycle carefully at moderate speed during the first 200 kilometers with new tires, tilting the vehicle at different angles so that all sections are properly roughened. Tires will not display their full grip characteristics until they are properly run in.
- Wheels with a different rim diameter or other rim width may not be mounted otherwise the vehicle handling will no longer be safe.
- Observe the traffic regulations, drive defensively and trying to look ahead as far as possible so that any hazards can be recognized as early as possible.
- The faster you drive, the more sensitive your motorcycle will be to crosswind and changing road conditions. Your motorcycle can easily go out of control at high speeds.
- Choose your driving speed according to the conditions and your driving skills.
- Drive carefully on unknown roads or on unfamiliar trails.
- Renew the visor on your helmet on time so as to ensure optimum vision in any situation. When light shines directly on scratched visor, the operator will be blinded.

- You may only be accompanied by a passenger if your motorcycle is fitted and registered for such purposes.
- Never leave your motorcycle without supervision if the engine is running.

Accessories and payload

Accessory parts and baggage can significantly decrease a motorcycle's driving stability. Please observe the following warnings.

⚠ WARNING

- Never drive faster than 130 kph (80 mph) if you have mounted accessory parts on your motorcycle. Accessory parts can significantly impair the motorcycle's handling, especially in the maximum speed range.
- Never drive faster than 130 kph (80 mph) if your motorcycle is loaded with cases or other baggage. They will impair the motorcycle's handling at higher speeds and can easily cause it to go out of control
- If you have cases mounted, do not exceed the manufacturer's recommended maximum payload.
- Four loops are provided on the bottom of the seat to attach your luggage. Make sure your luggage does not extend beyond the silencer, otherwise it may become singed from the heat.
- Make sure your luggage does not cover the tail light.
- Baggage must be securely and adequately fastened; loose baggage will significantly

- impair driving safety.
- A high payload will change the motorcycle's handling and considerably increase the braking distance; adapt your driving speed accordingly.
- Never exceed the maximum permissible laden weight and the axle weights. The maximum permissible laden weight is made up of the following components:
 - Motorcycle ready for operation and tank full
 - Luggage
 - Driver and passenger with protective clothing and helmet

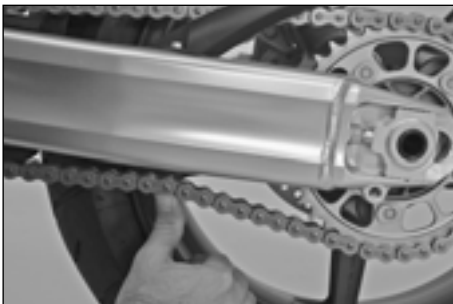

Check the following before each start

When you start, the motorcycle must be in perfect mechanical condition. For safety reasons, you should make a habit of performing an overall check of your motorcycle before each start.

The following checks should be performed:

1 FUEL

Check the fuel quantity in the tanks.

2 CHAIN

Check the tension and condition of the chain.

A loose chain can fall off the sprockets and a worn-out chain can tear. In both cases this can damage other motorcycle components and cause the motorcycle to go out of control. A chain that is too tight or not greased will cause unnecessary wear to the chain and sprockets.

3 TIRES

Check for damaged tires. Tires showing cuts or dents must be replaced. The tread depth must comply with the legal regulations. Also check the air pressure. Insufficient tread and incorrect air pressure deteriorate the driving performance.

4 BRAKES

Check correct functioning of the braking system. Check for sufficient brake fluid in the reservoir. The reservoirs have been designed in such a way that brake fluid does not need to be refilled even when the brake pads are worn. If the level of brake fluid falls below the minimum value, this indicates a leak in the braking system or completely worn out brake pads. Arrange for the braking system to be checked by a KTM specialist, as complete failure of the braking system can be avoided.

Also check the state of the brake hose and the thickness of the brake linings.

Check free travel at hand brake lever and foot brake lever.

5 CABLES

Check the throttle cable for correct adjustment and smooth operation.



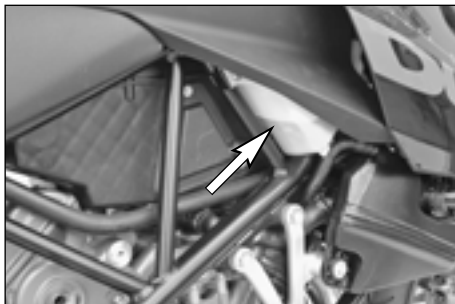

6 COOLING FLUID

Check the level of cooling fluid when the engine is cold.

7 ELECTRICAL SYSTEM

Start the engine and check the headlight, tail lamp, brake light, turn signals, indicator lamps, horn and emergency-off switch for proper functioning.

8 CHECK OIL LEVEL

Insufficient oil results in premature wear and consequently to engine damage.

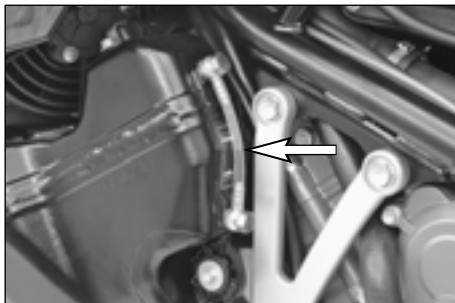

9 BAGGAGE, PAYLOAD

Never exceed the maximum total weight (387 kg, 853 lbs) and the motorcycle's wheel loads. The maximum total weight is comprised of:

- the motorcycle in a running condition and refueled (199 kg, 439 lbs)
- the baggage and accessories
- the driver and passenger with protective gear and helmet

Adjust the tire inflation pressure as well as the preload and damping properties of the fork and shock absorber to the total weight.

Make sure your luggage is correctly fastened before you drive off.



10 REAR MIRROR

Sit on the motorcycle and check the adjustment of the rear mirror.

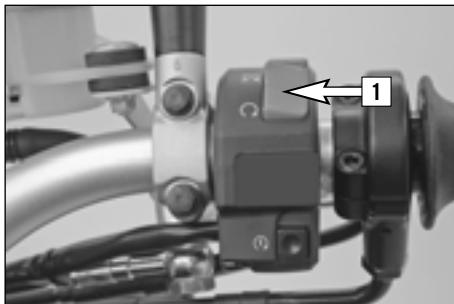

Starting the engine

- 1 Switch on emergency OFF switch [1].
- 2 Switch on ignition (turn ignition key [2] into position \odot).

NOTE:

You will hear the operation of the fuel pump for approx. 2 seconds after switching on the ignition. The **FI** indicator lamp will also light up during this time and the engine cannot be started.

- 3 Switch transmission to idle (green indicator lamp **N** [3] lights up).
- 4 **Do not accelerate**; operate starter button [5].

NOTE:

If you accelerate during the starting process you will hear a loud, metallic sound caused by the torque limiter. The torque limiter protects the components in the starter drive from being damaged.

- 5 The oil pressure warning lamp [4] should go out as soon as the engine is running.
- 6 Take the load off the side stand and fold the side stand all the way up.

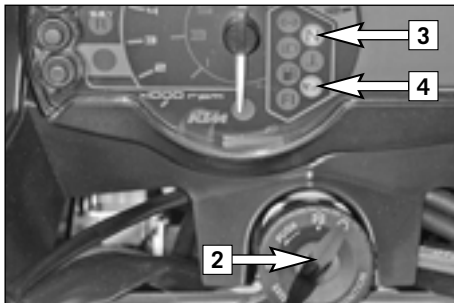

⚠ WARNING

- Do not start the engine and allow it to idle in a closed room. Exhaust fumes are poisonous and can cause loss of consciousness and death. Always provide adequate ventilation while the engine is running.
- Never operate the motorcycle with a run-down battery or without the battery. This can damage the electronic components or safety equipment in either case and the motorcycle will no longer be roadworthy.

! CAUTION

- If you accelerate while starting, the engine management will not inject any fuel and the engine will not start. Do not accelerate while starting!
- If the oil pressure warning lamp does not go out as soon as the engine is running, immediately switch off the engine. If the engine is not switched off, engine damage will occur within a short period of time. Check the engine oil level or contact a ktm workshop.
- Maximum period for continuous starting: 5 seconds. Wait at least 5 seconds before trying again.
- Don't ride your motorcycle with full load and don't rev engine when cold. Because the piston is warming up faster than the water cooled cylinder, it can cause engine damage. Always let the engine warm up before and refrain from driving with full load until the engine is warm.

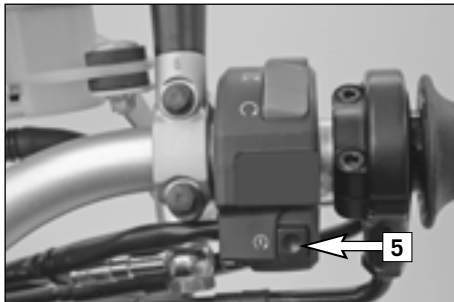

IF THE ENGINE DOES NOT CRANK WHEN YOU ACTUATE THE STARTER TIP SWITCH:

- whether you accelerated while starting
- the transmission is switched to idle
- Check if the emergency OFF switch is on
- Check if the ignition is on
- the headlight is on
 - If this is not the case, the battery is discharged
 - If the lights are on, proceed as described in the „Trouble-shooting“ section or contact a KTM dealer.

IF THE ENGINE CRANKS BUT DOES NOT START, WHEN YOU ACTUATE THE STARTER TIP SWITCH:

- whether you accelerated while starting
- whether the **FI** indicator lamp is blinking
 - if yes, check Troubleshooting - Blink codes table
- Check if sufficient fuel is in the tank
 - If this is not the case, refill the tank
 - if sufficient fuel is in the tank, proceed as described in the „Trouble-shooting“ section or contact a KTM dealer.

NOTE:

This motorcycle is equipped with a safety starting system. The engine can only be started if the transmission is in neutral or the clutch lever is pulled. If the side stand is folded down, the engine can only be started if the transmission is in neutral or the clutch lever is

pulled. The engine will stall if a gear is engaged and the clutch lever is released with the side stand folded down.

Starting off

Pull the clutch lever and engage 1st gear. Slowly release the clutch lever while you gently accelerate.

WARNING

Do not attach a helmet or other objects to the helmet lock rope while driving. You can easily lose control of the motorcycle.

Shifting/Riding

You are now in first gear, referred to as the drive or uphill gear. Depending on the conditions (traffic, road gradient, etc.), you can shift to a higher gear. Close throttle, at the same time pull clutch lever and shift to the next higher gear. Let clutch lever go again and carefully open throttle. Do not shift gears and accelerate carefully in curves.

Only accelerate to the extent that road and weather conditions allow. Be especially careful when you accelerate in curves. Abrupt opening of the throttle can cause the motorcycle to go out of control and also increases fuel consumption.

By shifting down, use the brakes if necessary and close throttle at the same time. Pull clutch lever and shift down to the next gear.

Let clutch lever go slowly and open throttle or shift down again.

If the engine is killed f.ex. at a crossing, simply pull the clutch lever and start. It is not necessary to switch the gear to NEUTRAL. Stop immediately if the FI indicator lamp lights up while driving. The FI indicator lamp will start blinking as soon as the transmission is in neutral. The rhythm of the blinking lamp will let you determine the two-digit „blink code“, e.g.:



Blink code 34: FI blinks 3x long, 4x short, pause,

Blink code 06: FI blinks 6x short, pause
The blink code will indicate which component is defective (see Troubleshooting). This makes it possible to pinpoint the defect if a diagnostic tool is unavailable.

WARNING

- **Avoid abrupt load changes while riding around bends and on wet or slippery ground. Otherwise you might easily lose control over your motorcycle.**

WARNING

- While riding your motorcycle, never switch the ignition lock to positions  and .
- Do not try to change the settings of the combined instrument while driving. Your attention will be distracted from the traffic and this may cause you to lose control of your motorcycle.
- The frost symbol * in the combined instrument will start to blink on icy roads. Adapt your speed to the road and weather conditions.
- The passenger must hold on to the driver or the holding strap on the seat while riding and keep his/her feet on the passenger footrests.
- Regularly make sure that the baggage and cases are tightly fastened.
- After falling with the motorcycle, check all functions thoroughly before starting up operations again.
- A bent handlebar must always be replaced. Never try to straighten the handlebar because this will cause it to lose its stability.

CAUTION

- High rpm rates when the engine is cold have an adverse effect on the life of your engine. We recommend you run the engine in a moderate rpm range for a few miles giving it a chance to warm up. After that no further precautions in this respect need be taken. The engine has reached operating temperature as soon as the 4th

bar on the temperature indicator lights up.

- If the red oil pressure warning lamp lights up while driving, the oil pressure is too low to adequately lubricate the engine. Stop immediately and switch off the engine. If you continue to drive, engine damage will occur within a short period of time. Check the engine oil level or contact an authorized KTM workshop.
- Never have the throttle wide open when changing down to a lower gear. The engine will overspeed, damaging the valves. In addition, the rear wheel blocks so that the motorcycle can easily get out of control.
- Never use your motorcycle without an air filter. Otherwise dust and dirt may enter the engine and cause increased wear.
- Stop immediately if a perceptible power loss occurs while driving due to a defective ignition caused by a cylinder misfiring or breaking down. If the unburned fuel/air mixture reaches the catalytic converter, it will ignite and the resulting heat will destroy the catalytic converter and the adjoining components.
- The red coolant warning lamp lights up when the coolant temperature has reached 120°C (248°F).

Possible causes for the increase in temperature:

- low driving velocity and high load situation in high air temperatures
- level of coolant in the system is insufficient
- fan at radiator is not running

- improper use of the clutch while driving at low velocities

Let the engine cool down. Meanwhile, check whether any cooling liquid is leaking out of the motorcycle. Check the cooling liquid level in the radiator (not only in the compensating tank). - CAUTION SCALDING HAZARD! Do not drive on, until there is sufficient liquid in the cooling system.

- In the event that, while riding on your motorcycle, you notice any unusual operation-related noise, stop immediately, turn the engine off, and contact an authorized KTM dealer.

Braking

Close throttle and apply the hand and foot brakes at the same time. Carefully apply the brakes on sandy, wet or slippery surfaces. Always brake with feeling, blocking wheels can cause you to skid or fall. Also change down to lower gears depending on your speed. Always finish braking before you enter a curve.

When driving downhill, use the braking effect of the engine. Change down one or two gears but do not overspeed the engine. In this way, you will not need to brake so much and the brakes will not overheat.

WARNING

- In the rain, or after the motorcycle has been washed, braking action may be delayed due to wet brake discs. First, the brakes must be braked dry.

⚠ WARNING

- On salt-sprayed or dirty roads brake action may be delayed as well. First, the brakes must be braked clean.
- Remember that the stopping distance will be longer if you are carrying a passenger or baggage.



- When you brake, the brake discs, brake pads, brake caliper and brake fluid heat up. The hotter these parts get, the weaker the braking effect. In extreme cases, the entire braking system can fail.
- If the resistance in the hand brake lever or foot brake pedal feels „spongy“ (too much play), this is an indication that

something is wrong with the brake system. Don't ride your motorcycle anymore without first having the brake system looked over by a KTM dealer.

Stopping and parking

Apply the brakes fully and put the engine into neutral. To stop the engine, switch off the ignition. Fold the side stand forward to the stop with your foot, put the weight of the motorcycle on the stand and park the bike on a firm surface. Lock the motorcycle.

⚠ WARNING

- always park your motorbike on a solid and horizontal surface.
- Never leave your motorcycle without supervision as long as the engine is running.
- Motorcycle engines produce a great amount of heat while running. The engine radiators, exhaust, exhaust system, brake discs, and shock absorbers can become very hot. Do not touch any of these parts after operating the motorcycle, and take care to park it where pedestrians are not likely to touch it and get burned
- Never park your motorcycle in places where there exist fire hazards due to dry grass or other easily flammable materials.

! CAUTION

- Always take out the ignition key when parking your motorcycle so that it cannot be used by unauthorized persons.
- The side stand is dimensioned for the weight of the motorcycle only. Sitting on the motorcycle will increase the weight on the side stand. The side stand or engine case can be damaged and the motorcycle can tip over.

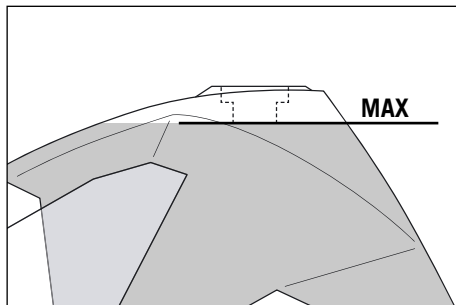

Fuel

In the condition at delivery, the LC8 engine requires unleaded fuel with at least RON 95 (USA = Premium PON 91, see technical specifications – engine).

After refueling, it will take approx. 3 minutes for the fuel warning lamp to switch off and for TRIP F to automatically reset to 0 and return to the previous display mode.

NOTE:

Press the SET key for 2 seconds to immediately turn off the fuel warning lamp.

! CAUTION

This motorcycle is equipped with a catalytic converter that will be destroyed if you use leaded fuel. Always use unleaded fuel.

Fuel expands when its temperature rises. Therefore do not fill the tank to the top (see fig.).

⚠ WARNING

Gasoline is highly flammable and poisonous. Extreme caution should be used when handling gasoline. Do not refuel the motorcycle near open flames or burning cigarettes. Always switch off the engine before refuelling. Be careful not to spill gasoline on the engine or exhaust pipe while the engine is hot. Wipe up spills promptly. If gasoline is swallowed or splashed in the eyes, seek a doctor's advice immediately.

990 SUPER DUKE / R 2008 A clean motorcycle can be checked more quickly which saves money!		1st Service after 1000 km	every 7500 km or once a year	every 15000 km or every 2 years
ENGINE	Change engine oil and oil filter	●	●	●
	Clean oil screens of engine and oil tank	●	●	●
	Clean magnetic drain plugs of engine and oil tank	●	●	●
	Check oil lines for damage and kink-less arrangement	●	●	●
	Renew spark plugs			●
	Check and adjust valve clearance	● (Super Duke only)		●
	Check engine fastening bolts for tight fit	●	●	●
	Check all engine bolts accessible from the outside for tight fit	●	●	●
	Check clutch linings			●
	Check clutch pressure booster system			●
Clean the oil jet for the clutch lubrication	●		●	
FUEL INJECTION	Check rubber boots for cracks or leaks	●		●
	Check fault memory with the KTM diagnosis tool	●	●	●
	Perform a status check of neutral, clutch, 2nd/3rd gear and side stand switch using the KTM diagnosis tool	●	●	●
	Make sure the fuel hose, hoses on the vacuum sensors, SAS hoses and vent hoses are run correctly and check for damage	●	●	●
	Replace the O-ring on the fuel hose connection and check for leaks	●	●	●
	Check the wiring harness on the throttle body for proper installation and damage	●		●
ADD-ON PARTS	Check cooling system for leaks and antifreeze protection	●	●	●
	Check radiator fan for proper operation	●	●	●
	Check the exhaust system for leaks and correct suspension and the clamps for a tight fit	●	●	●

990 SUPER DUKE / R 2008 A clean motorcycle can be checked more quickly which saves money!		1st Service after 1000 km	every 7500 km or once a year	every 15000 km or every 2 years
ADD-ON-PARTS	Replace the graphite gasket in the rear exhaust manifold slide			●
	Check actuating cables for damage, smooth operation, and kink-less arrangement, adjust and lubricate	●	●	●
	Check the oil level in the hydraulic clutch reservoir		●	●
	Check air filter, renew if necessary, clean air filter box			●
	Check cables for damage and kink-less arrangement	●	●	●
	Check headlamp adjustment	●	●	●
	Check electrical system for function (low/high beams, stop light, turn indicators, headlamp, flasher, tell-tale lamps, speedometer illumination, horn, side-stand switch, clutch switch, emergency-off switch)	●	●	●
	Make sure all bolts and nuts are tight	●	●	●
BRAKES	Check brake fluid level, lining thickness, and brake discs	●	●	●
	Change brake fluid			●
	Check brake lines for damage and leaks	●	●	●
	Check/adjust smooth operation, free travel of handbrake/footbrake levers	●	●	●
	Check bolts of brake system for tight fit	●	●	●
CHASSIS	Check shock absorber and fork for leaks and proper operation	●	●	●
	Clean fork dust sleeves		●	●
	Bleed fork legs	●	●	●
	Check swinging-fork pivot	●	●	●
	Check/adjust steering-head bearing	●	●	●
Check all chassis bolts for tight fit (fork plates, fork leg, axle nuts/bolts, swinging-fork pivot, reversing lever, shock absorber)	●	●	●	

990 SUPER DUKE / R 2008 A clean motorcycle can be checked more quickly which saves money!		1st Service after 1000 km	every 7500 km or once a year	every 15000 km or every 2 years
WHEELS	Check rim joint	●	●	●
	Check tire condition and inflation pressure	●	●	●
	Check chain, sprockets and chain guides for wear, force fit and tension	●	●	●
	Check bolts on pinion and chain sprocket for locking devices and a tight fit	●	●	●
	Lubricate chain	●	●	●
	Check wheel bearings and jerk damper for play		●	●

IF MOTORCYCLE IS USED FOR COMPETITION 7500 KM SERVICE SHOULD BE CARRIED OUT AFTER EVERY RACE!
 Service intervalls should never be exceeded by more than 500 km.
 Maintenance work performed by an authorized KTM workshop is not a substitute for care and maintenance by the driver!

990 SUPER DUKE / R 2008 ADDITIONAL SERVICE WORK TO BE PERFORMED UNDER A SEPARATE ORDER		
	at least once a year	every 15000 km or every 2 years
Perform complete fork maintenance		●
Perform complete shock absorber maintenance		●
Clean and lubricate steering-head bearing and sealing elements	●	
Treat the electrical contacts and switches with contact spray	●	
Treat battery connections with contact grease	●	
Change coolant fluid		●

990 SUPER DUKE / R 2008 VITAL CHECKS AND CARE PROCEDURES TO CONDUCTED BY THE OWNER OR THE MECHANIC			
	before each start	after every cleaning	every 1000 km
Check oil level	●		
Check brake fluid level	●		
Check brake pads for wear	●		
Check lighting system for proper operation	●		
Check horn for proper operation	●		
Lubricate actuating cables and nipples		●	
Bleed fork legs			●
Clean chain			●
Lubricate chain		●	●
Check chain tension	●		
Check tire pressure and wear	●		
Check coolant level	●		
Check fuel lines for leaks	●		
Check all control elements for smooth running	●		
Grease the hand brake lever and clutch lever		●	
Check brake performance	●	●	
Treat exposed metal components (except for the braking and exhaust system) with wax-based anti-corrosion agents		●	
Treat ignition/steering lock and light switch with contact spray		●	

! CAUTION

- Do not clean the motorcycle with a power washer otherwise water will get into the bearings, electric socket connectors, etc.
- Use special KTM screws with the correct thread length to fasten the spoiler to the tank. Mounting other screws or longer screws could puncture the tank and cause fuel to leak out.
- If you disconnect socket connectors with self-locking nuts, replace them before remounting. If no new self-locking nuts are available, apply Loctite 243 to the thread of the old nuts. If the thread is damaged, replace the screws and nuts.
- Do not use toothed disks or split washers for the engine fastening bolts since they will work their way into the frame components and become loose. Always use self-locking nuts.
- Let the motorcycle cool down before servicing to avoid being burned.
- Properly dispose of oils grease, filters, fuel, cleansers, etc. Observe the regulations effective in your country.
- Never pour used oil in the sewer or dispose of it outdoors. 1 liter of used oil will pollute 1,000,000 liters of water.

BASIC SETTING FORK WP 4860 ROMA	Super Duke			Super Duke R					
	Driving Comfort	Basic Setting	Driving Sport	Maximum Payload	Basic Setting	Driving Sport	Race course	Maximum Payload	
	Compression adjuster (clicks)	20	15	10	10	18	18	14	18
	Rebound adjuster (clicks)	20	15	10	10	16	16	12	16
Spring preload (turns)	5	5	5	5	5	5	5	5	

Adjusting the fork and shock absorber

There are a number of ways to adjust the fork and shock absorber to match the chassis to your driving style and the payload.

We have provided a table with pragmatival values to help you tune up your motorcycle. These tune-up specifications are reference values only and should serve as a basis for your personal chassis and suspension tuning. Do not make arbitrary changes to the settings (maximum $\pm 40\%$) since this may impair the handling characteristics (particularly in the high-speed range).

Make sure both fork legs are equally adjusted.

A sticker with the basic settings is located under the seat.

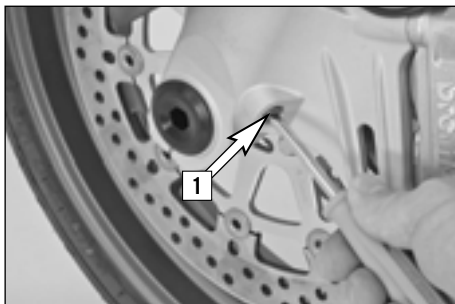

Adjusting compression damping of fork

Hydraulic compression damping determines the reaction when the fork is compressed.

Turn the adjusting screws [1] clockwise to increase damping, turn it counterclockwise to reduce damping during compression. Make the same damping rate adjustment to both fork legs.

STANDARD ADJUSTMENT

- Turn adjusting screw clockwise as far as it will go.
- Super Duke: Turn 15 clicks in a counterclockwise direction.
- Super Duke R: Turn 18 clicks in a counterclockwise direction.

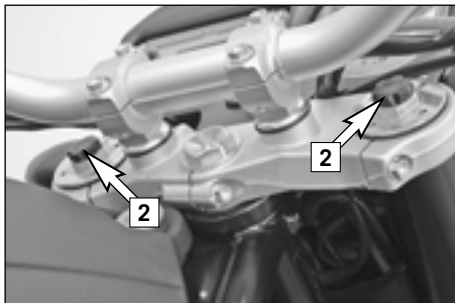

Adjusting rebound damping of fork

Hydraulic rebound damping determines the reaction when the fork is rebound. By turning the adjusting screw [2] (REB), the degree of damping of the rebound can be adjusted. Turn the knob clockwise to increase damping, turn it counterclockwise to reduce damping during rebounding. Make the same damping rate adjustment to both fork legs.

STANDARD ADJUSTMENT

- Turn adjusting screw clockwise as far as it will go.
- Super Duke: Turn 15 clicks in a counterclockwise direction.
- Super Duke R: Turn 16 clicks in a counterclockwise direction.

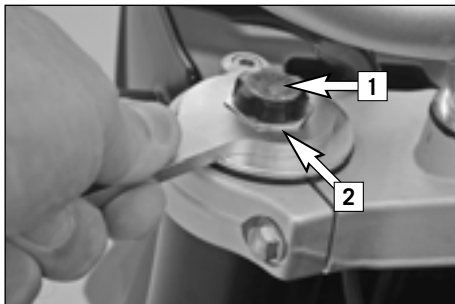

Adjusting the spring preload on the fork

The fork spring preload can be adjusted by turning the adjusting screws [2] (wrench size 24 mm) ± 5 mm (0,2 in).

Turning in a clockwise direction will increase the preload, turning in a counterclockwise direction will decrease the preload. 1 turn will change the preload by 1 mm.

Changing the preload will not affect the rebound damping adjustment, although adjusting screw [1] will turn at the same time. Make the same spring preload adjustments to both fork legs.

Generally, if the preload is higher, the rebound damping should also be set higher.

STANDARD ADJUSTMENT:

- Turn adjusting screw counterclockwise as far as it will go.
- Turn 5 turns in a clockwise direction.

BASIC SETTING SHOCK ABSORBER WP 4618 BAVP	Super Duke		Super Duke R					
	Driving Comfort	Basic Setting	Driving Sport	Maximum Payload	Basic Setting	Driving Sport	Race course	Maximum Payload
	Compression adj. Low Speed (clicks)	25	20	10	10	20	16	10
Compression adj. High Speed (turns)	2	1.5	1	1	2.5	1.5	1	1,5
Rebound adjuster (clicks)	20	12	8	8	12	12	8	12
Spring preload (mm)	6	6	6	6	5	5	5	5



Compression damping of shock absorber

The shock absorber can synchronize the compression damping in the low and high-speed range separately (Dual Compression Control).

Low and high speed refers to the movement of the shock absorber during compression and not to the speed of the motorcycle.

The low and high-speed technology overlaps.

The low-speed setting is primarily for slow to normal shock absorber compression rates.

The high-speed setting is effective at fast compression rates.

Turning in a clockwise direction will increase the damping, turning counterclockwise will decrease the damping.

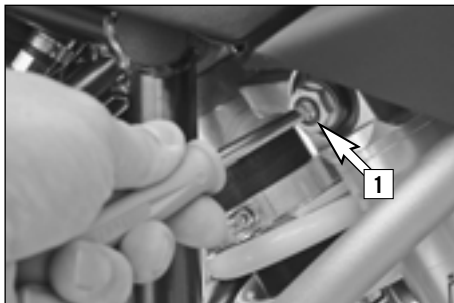

STANDARD ADJUSTMENT LOW-SPEED:

- Turn adjusting screw [1] clockwise as far as it will go.
- Turn 20 clicks in a counterclockwise direction.



STANDARD ADJUSTMENT HIGH-SPEED:

- Turn adjusting screw (wrench size 17 mm) clockwise as far as it will go.
- Super Duke: Turn 1.5 turns in a counterclockwise direction.
- Super Duke R: Turn 2.5 turns in a counterclockwise direction.

WARNING

The damping unit of the shock absorber is filled with high-compression nitrogen. Never try to take the shock absorber apart or to do any maintenance work yourself. Severe injuries could be the result.

Never unscrew the black screw connection (24mm).

Rebound damping of shock absorber

By using the adjusting screw [2], the degree of damping of the rebound can be adjusted. Turn the knob in a clockwise direction to increase damping, turn it in a counterclockwise direction to reduce damping during rebounding.

STANDARD ADJUSTMENT:

- Turn adjusting screw [2] clockwise as far as it will go.
- Turn 12 clicks in a counterclockwise direction.

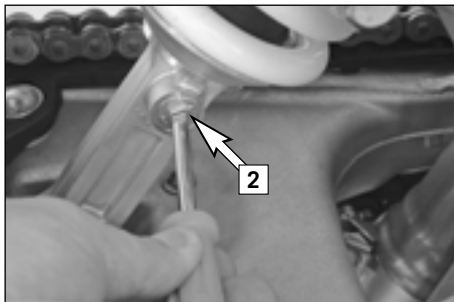

WARNING

The damping unit of the shock absorber is filled with high-compression nitrogen. Never try to take the shock absorber apart or to do any maintenance work yourself. Severe injuries could be the result.

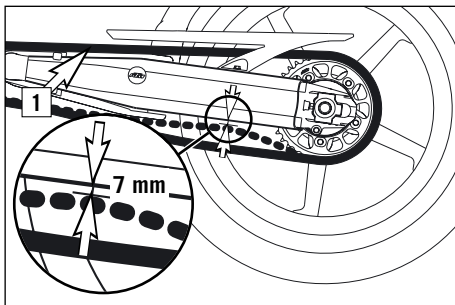

Checking the chain tension

Place the motorcycle on the side stand. Switch the transmission to neutral and push the chain up. The distance between the chain and the swing arm should be 7 mm when the upper part of the chain [1] is tensioned (see drawing). Correct the chain tension if necessary.

⚠ WARNING

- If chain tension is too great, parts within the secondary power transmission (chain, chain sprockets, transmission and rear wheel bearings) will be subjected to unnecessary stress, resulting in premature wear and even chain breakage.
- Too much slack in the chain, on the other hand, can result in the chain jumping off the chain wheels. If this happens, the chain could also block the rear wheel or damage the engine.
- In either case the operator is likely to lose control of the motorcycle.

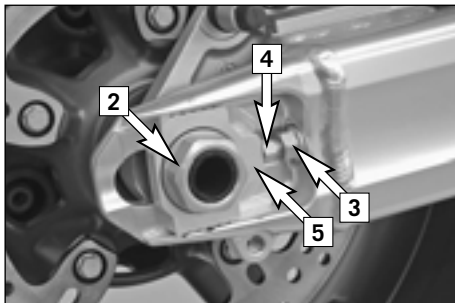

Correcting the chain tension

Loosen the collar nut [2], loosen the counternuts [3] and turn the left and right adjustment screws [4] the same distance. Tighten the counternuts [3].

To make sure the rear wheel is aligned, the marks on the chain tensioners must be in the same position on the left and right in relation to the reference marks [A]. Before tightening the wheel spindle make sure the chain tensioner [5] rests against the adjustment screws and the rear wheel is aligned with the front wheel.

Tighten the collar nut [2] to 90 Nm.

⚠ WARNING

If you don't happen to have a torque wrench at hand, make sure you have the tightening torque corrected by a KTM dealer as soon as possible. A loose axle may lead to an unstable driving behavior of your motorcycle.

NOTE:

The large adjusting range of the chain adjusters (32mm) allows you to use different secondary ratios in combination with the same chain length. The chain adjusters [5] can be rotated by 180°.

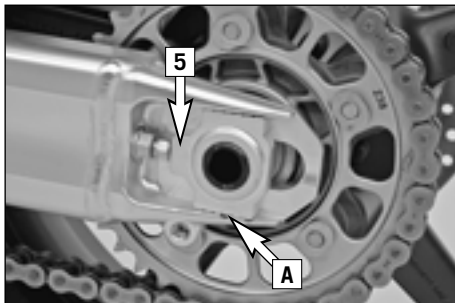

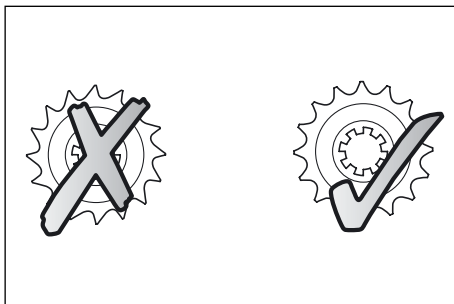

Chain maintenance

Maintenance of the X-ring chain is reduced to a minimum. Rinse off any heavy dirt with plenty of water. Residual used grease must be removed prior to lubrication (Motorex Chain Clean 611). After drying, use a chain spray specially designed for X-ring chains (Motorex Chainlube 622 Strong).

⚠ WARNING

- No lubrication is allowed to reach the rear tire or the brake disk, otherwise the road adherence and the rear wheel braking effects would be strongly reduced and the motorcycle could easily get out of control.
- The chain does not have a chain joint for safety reasons. Always have the chain replaced in an authorized KTM workshop where the service technicians have the required riveting tool.
- Never mount a normal chain joint.

Also check sprockets and chain guides for wear, and replace if necessary.

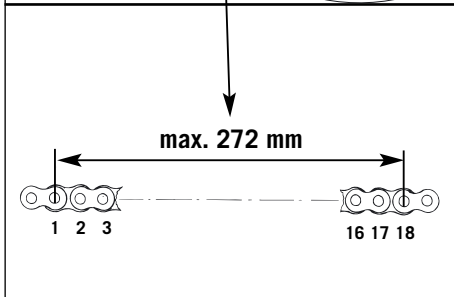
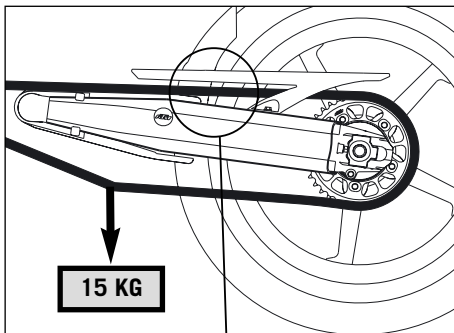

Checking the chain for wear

To check the chain for wear proceed as follows:
Switch the transmission to idle and put a load of approx. 15 kilograms (33 lbs) on the lower part of the chain (see illustration). Now measure the distance between 18 chain rollers on the upper part of the chain. The chain needs to be replaced when the distance is 272 mm (10.70 in). Since chains do not always wear evenly, repeat the measurement at different parts of the chain.
Replace the chain if any X-rings are missing.

NOTE:

If you mount a new chain, the sprockets should also be replaced. New chains wear faster if used on old used sprockets.

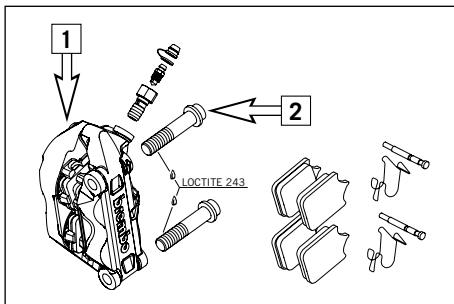

General information on KTM disk brakes

BRAKE CALIPERS:

The front brake calipers [1] have 4 brake pistons and are radially bolted to the fork legs. The front brake disks are designed as „floating“ brake disks, i.e. they are not firmly connected to the front wheel.

The lateral balance ensures that the brake pads always have the best possible contact to the brake disk. Apply Loctite 243 to the screws [2] on the brake caliper support and tighten to 45 Nm.

The rear brake caliper [3] has 1 brake piston and is designed as a „floating brake caliper“, i.e. it is not firmly connected to the brake caliper support. The lateral balance ensures that the brake pads always have the best possible contact to the brake disk.

⚠ WARNING

For safety reasons, always have maintenance work and repairs to the brake system performed by an authorized KTM workshop.

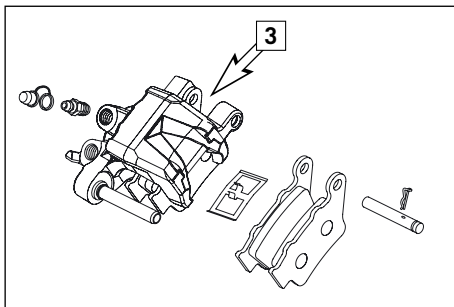

BRAKE PADS:

Your motorcycle is equipped with sintered brake pads in the front and rear and homologated accordingly. They guarantee maximum braking performance.

Front brake pads: HAWK 7342-49

Rear brake pads: TOSHIBA TTH 38 GF

⚠ WARNING

Brake pads available in the accessory trade are often not authorized for operation of your KTM motorcycle in road traffic. The brake pads design and friction factor and therefore the braking power can deviate significantly from original KTM brake pads. If you use different brake pads than those provided with the original equipment, it cannot be warranted that they are authorized for use in road traffic. Your motorcycle will not longer comply with the regulations authorizing the use of vehicles for road traffic and the warranty will be void.



BRAKE FLUID RESERVOIRS:

The brake fluid reservoirs on the front and rear wheel brakes have been designed in such a way that even if the brake pads are worn it is not necessary to top up the brake fluid. There is no reason to remove the reservoir cap under normal conditions. If the brake fluid level drops below the minimum either the brake system has a leak or the brake pads are completely worn down. In this case, consult an authorized KTM dealer immediately.

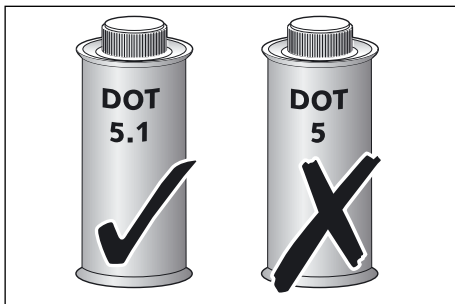

BRAKE FLUID:

We recommend that you use Motorex DOT 5.1 brake fluid when you refill or change the brake fluid. DOT 5.1 brake fluid has a wet boiling point of 180°C / 356°F (25°C / 45°F higher than DOT 4) and is safer for high performance applications. Brake fluid DOT 5.1 is a polyethylene glycol based fluid, amber-colored and can be mixed with DOT 4 brake fluid. **Do not, in any event, use DOT 5 brake fluid.** It is based on silicone oil and is dyed purple. KTM motorcycle gaskets and brake hoses are not designed for DOT 5 brake fluid.

Brake fluid is exposed to a high thermal load and absorbs moisture from the air, which lowers the boiling point. The brake fluid should therefore be changed at the prescribed intervals.

WARNING

Have the brake fluid for the front and rear brake changed at an authorized KTM workshop every 2 years.

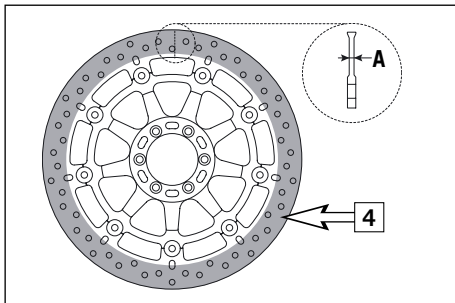

BRAKE DISCS:

Wear reduces the thickness of the brake disc in the area of contact [4] with the brake pads. The brake disc should not be thinner than 4 mm (0.16 in) at the weakest point [A]. Check the wear at several points.

WARNING

Brake disks that are less than 4 mm (0.16 in) thick are a safety hazard. Have worn brake disks replaced immediately.

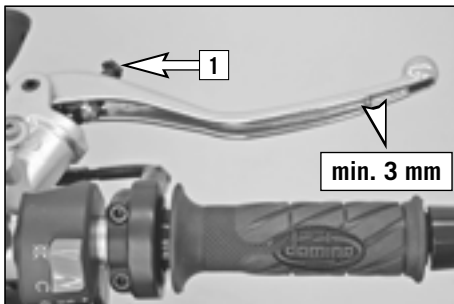

Adjusting the basic position of the hand brake lever

The basic position of the hand brake lever can be modified by turning the adjusting screw [1]. This lets you adapt the position of the pressure point (the resistance you feel on the hand brake lever when the brake pads are pressed against the brake disk) to fit any hand.

! CAUTION

At the hand brake lever, free travel must at least be 3 mm (0.12 in). Only then may the piston in the hand brake cylinder be moved (to be recognized by the greater resistance of the hand brake lever). If this free travel is not provided, pressure will build up in the braking system, and the front wheel brake may fail due to overheating.



Checking the front brake fluid level

The brake fluid reservoir for the front brake is located on the left side of the handlebar and has a „MIN“ and a „MAX“ mark. The brake fluid level may not fall below the „MIN“ mark when the vehicle is parked in a vertical position.

⚠ WARNING

- If the brake fluid level drops below the minimum either the brake system has a leak or the brake pads are completely worn down. In this case, consult an authorized KTM dealer immediately.
- Have the brake fluid changed at an authorized KTM workshop every 2 years.

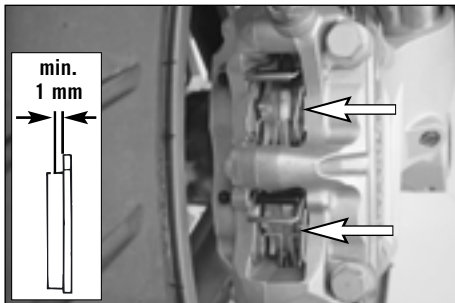

Checking the front brake pads

The brake pads can be inspected from the rear. The linings must be at least 1 mm (0.04 in) thick.

WARNING

At their most worn point brake pad linings should not be thinner than 1 mm, otherwise they could lead to brake failure. For your own safety don't put off having your brake pads changed.

CAUTION

If the brake pads are replaced too late when the lining is partly or completely worn off, the steel parts on the brake pads will grind against the brake disks. This significantly decreases the braking effect and destroys the brake disks.



Checking the rear brake fluid level

The brake fluid reservoir for the rear brake is located on the rear right of the vehicle and has a "MIN" and a "MAX" mark. The brake fluid level may not fall below the "MIN" mark when the vehicle is parked in an upright position.

WARNING

- If the brake fluid level drops below the minimum either the brake system has a leak or the brake pads are completely worn down. In this case, consult an authorized KTM dealer immediately.
- Have the brake fluid changed at an authorized KTM workshop every 2 years.

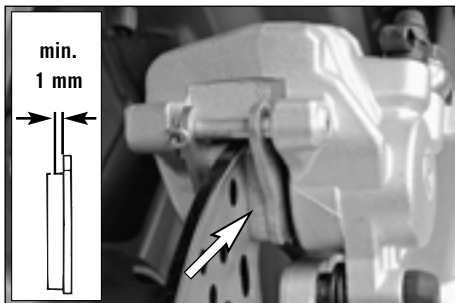

Checking the rear brake pads

The brake pads can be inspected from the rear. The thickness of the linings may not be less than 1 mm (0.04 in).

WARNING

At their most worn point brake pad linings should not be thinner than 1 mm, otherwise they could lead to brake failure. For your own safety don't put off having your brake pads changed.

CAUTION

If the brake pads are replaced too late so that the lining is partly or entirely worn away, the steel components of the brake pad will rub against the brake disc, impairing the braking effect and destroying the brake disc.

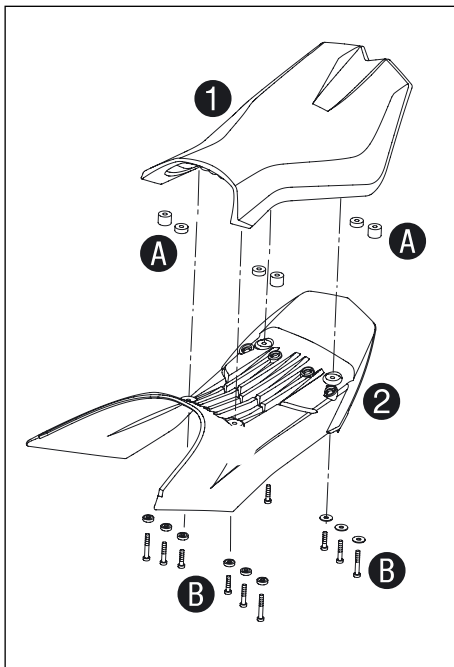

Changing the seat height (Super Duke R)

The seat height of the mono-seat can be raised by 7 or 15 mm (0.3 or 0.6 in). The parts required are supplied with the bike.

Remove the seat and the screws [B]. Fit 4 spacers [A] at the same height front and back between the seat [1] and the seat carrier [2] and insert screws with the appropriate length.

- No spacers M6x16 screws
- 7 mm (0.3 in) spacers M6x20 screws
- 15 mm (0.6 in) spacers M6x30 screws

Tighten the screws to 10 Nm.



Dismounting and remounting the front wheel

Special stands are required to dismount the wheels to make sure the motorcycle is securely fixed. The front stand only adequately fixes the motorcycle together with the rear stand. The stands shown in the illustration can be found in the KTM Power Parts catalog.

First mount the rear, then the front stand. Make sure the stands rest on solid ground and are correctly mounted. The front wheel should not touch the ground.

NOTE FOR SUPER DUKE R:
First remove the crash pads.

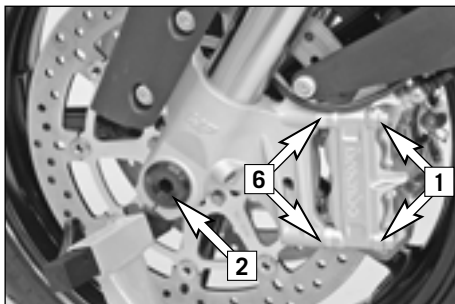

Remove the screws [1] on the left and right brake caliper and carefully pull the brake calipers and bushings [6] off the brake disks towards the back.

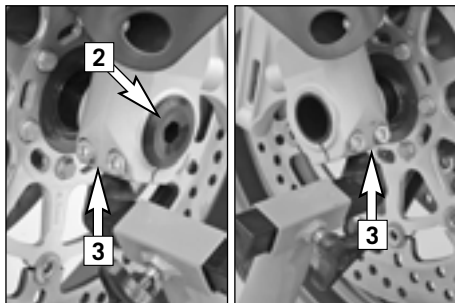

Loosen the collar screw [2] and the clamping screws [3] on both fork leg axle passages. Unscrew the collar screw approx 8 turns, press on the collar screw with your hand to push the wheel spindle out of the fork leg axle passage and remove the collar screw. Hold the front wheel while you pull out the wheel spindle. Lift the front wheel off the fork.

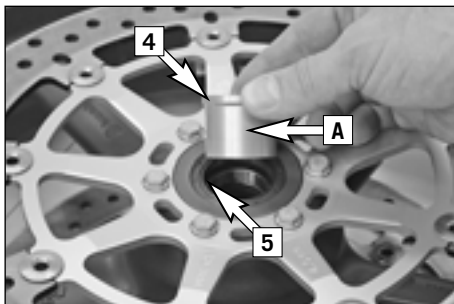

Take the left [4] and right distance bushing out of the shaft seal rings.

! CAUTION

- Do not operate the hand brake when the front wheel has been dismantled.
- Be careful not to damage the brake disks when you lay the front wheel down.

Before you remount the front wheel, clean and grease the shaft seal rings [5] and the bearing surface [A] of the distance bushings and mount the distance bushings (wide distance bushing in the left shaft seal ring). When mounting the distance bushing, be careful not to press the sealing lips towards the inside. position the front wheel according to the running direction shown by the arrows [B] on the rim.

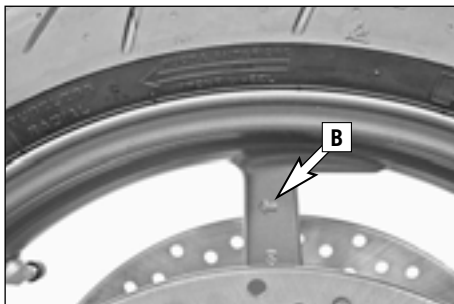

To mount, lift the front wheel in the fork and mount the wheel spindle and collar screw [2]. Tighten the collar screw to 60 Nm. Position the brake calipers and bushings [6] and make sure the brake pads are correctly seated. Apply Loctite 243 to the screws [11], mount the screws and tighten to 45 Nm.

Take the motorcycle off the front stand, actuate the front wheel brake and vigorously compress the fork several times to align the fork legs.

Before you tighten the clamp screws [3] check whether the right brake disk [C] runs in the center of the brake caliper. Move the right fork leg to the side if necessary, then tighten the clamp screws on both fork leg axle passages to 15 Nm. Actuate the hand brake until you feel the pressure point and check whether the front wheel can easily be turned. Remove the rear stand.

⚠ WARNING

- If you do not have a torque wrench to mount the wheel, have the torques corrected by an authorized KTM workshop as soon as possible. A loose wheel spindle can cause the motorcycle's handling performance to become instable and cause it to crash.
- After mounting the front wheel, keep operating the hand brake until the pressure point returns.
- Always keep the brake disks free from oil and grease, otherwise the braking effect will be significantly reduced.

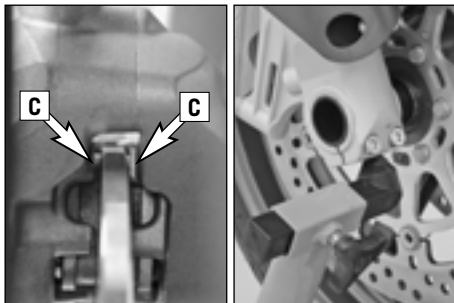

NOTE FOR SUPER DUKE R: remount the crash pads.



Dismounting and mounting the rear wheel

Special stands are required to dismount the wheels to make sure the motorcycle is securely fixed. The stands shown in the illustration can be found in the KTM Power Parts catalog.

Mount the rear stand. Make sure the stand rests on solid ground and is correctly mounted. The rear wheel should not touch the ground

NOTE FOR SUPER DUKE R:
First remove the crash pads.

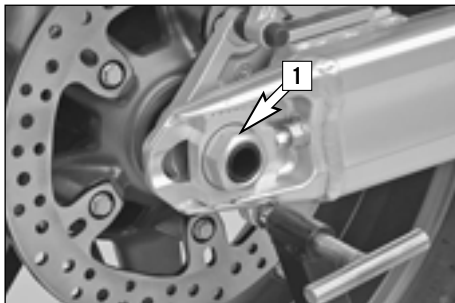

Unscrew the collar nut [1], remove the chain tensioner [2], hold the rear wheel while you pull out the wheel spindle [3]. Push the rear wheel forward as far as possible and remove the chain from the rear sprocket. Carefully take the rear wheel off the swing arm.

! CAUTION

- Do not operate the rear brake when the rear wheel has been dismounted.
- Always place the wheel on the ground with the brake disc pointing upwards. Otherwise the brake disc may be damaged.
- If the axle is dismounted, clean the thread of the wheel spindle and collar nut thoroughly and apply a new coat of grease (Motorex Long Term 2000) to prevent the thread from jamming.

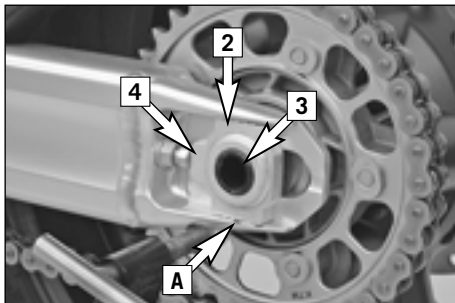

Before remounting the rear wheel, clean and grease the bearing surface of the bushings [5] and the shaft seal ring [6].

The rear wheel is remounted in the reverse order. Make sure the chain tensioners [4] are mounted in the same way on the left and right. The marks on the chain tensioners must be in the same position on the left and right in relation to the reference marks [A]. Before you tighten the collar nut to 90 Nm, press the rear wheel towards the front to allow the chain tensioner to rest against the clamping screws.

NOTE FOR SUPER DUKE R: remount the crash pads.



WARNING

- If you don't happen to have a torque wrench at hand, make sure you have the tightening torque corrected by a KTM dealer as soon as possible. A loose wheel spindle may lead to an unstable driving behavior of your motorcycle.
- After mounting the rear wheel, keep operating the footbrake until the pressure point returns.
- It is very important to keep the brake disk free from oil and grease, otherwise the braking effect would be strongly reduced.

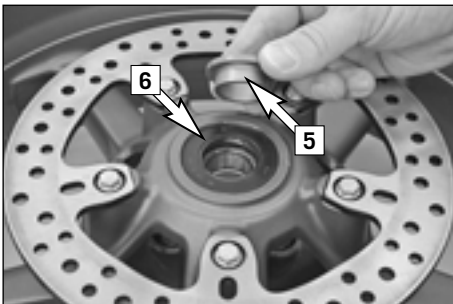

Tires, air pressure

Tire type, tire condition, and how much air pressure the tires have in them affect the way your motorcycle rides, and they must therefore be checked whenever you're getting ready to go anywhere on your motorcycle.

WARNING

For driving safety and maximum handling, only use tires authorized by KTM (tire releases are available on the Internet at www.ktm.com) corresponding to the „ZR“ speed index (over 240 KPH). Other tires can have a negative effect on the motorcycle's handling (e.g. can cause it to „wobble“ at higher speeds).

TIRES – AIR PRESSURE		
990 Super Duke / R	front	rear
Road, driver only	2.4 bar 34 psi	2.4 bar 34 psi
Road, with passenger	2.4 bar 34 psi	2.6 bar 37 psi
maximum payload	2.4 bar 34 psi	2.6 bar 37 psi

⚠ WARNING

- Do not mount tires which have not been approved by KTM. Other tires could have adverse effects on the way your motorcycle rides.
- Use tires of the same brand and type for the front and rear wheels.
- For your own safety replace damaged tires immediately.

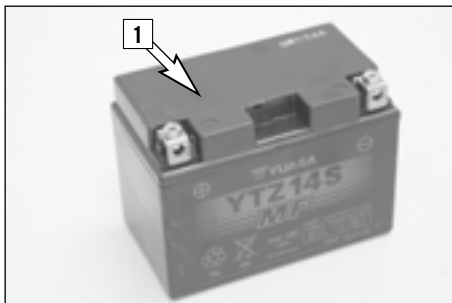

- Tire type and size can be found in the technical specifications and in the homologation certificate.
- Tire condition has to be checked every time you want to ride your motorcycle. Before leaving check for punctures and nails or other sharp objects that might have become embedded in the tire.
- Refer to the specific regulations in your country for minimum tire tread requirements. We recommend replacing tires at the latest when the tread is down to 2 mm (0.08 in).
- Tire pressure should be checked regularly on a „cold“ tire. Adapt the air pressure to the motorcycle's total weight. Proper pressure ensures optimum driving comfort and extends the life of your tires.

- Worn tires can have a negative effect on how your motorcycle performs, especially on wet surfaces.
- If air pressure is too low, abnormal wear and overheating of the tire can result.
- New tires have a smooth surface, which means that they must be run in to achieve full grip. For this purpose, ride the motorcycle carefully at moderate speed during the first 200 kilometers (125 miles) with

new tires, tilting the vehicle at different angles so that all sections are properly roughened. Tires will not display their full grip characteristics until they are properly run in.

- For reasons of safety, it is recommended to exchange the valve insert whenever a new tire is mounted.

Battery

The battery is located in the front spoiler in front of the engine and is maintenance-free. It is not necessary to check the electrolyte level or to refill water. Simply keep the battery poles clean and slightly grease them with an acid-free grease if necessary. The charge condition and type of charge are very important for the battery's service life.

⚠ WARNING

Never operate the motorcycle with a run-down battery or without the battery. This can damage the electronic components or safety equipment in either case and the motorcycle will no longer be roadworthy.

! CAUTION

Never remove the closing cover [1] otherwise the battery will be damaged.

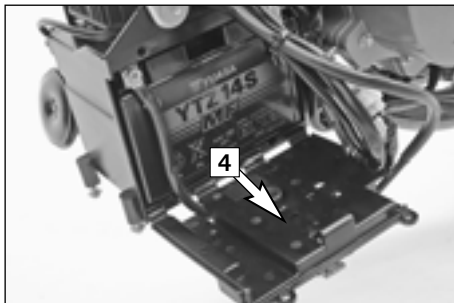
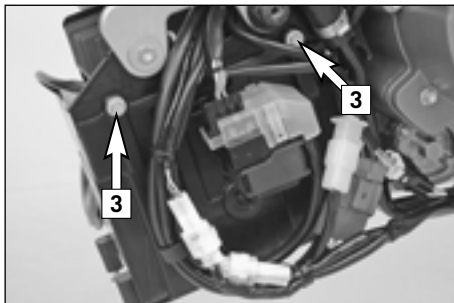
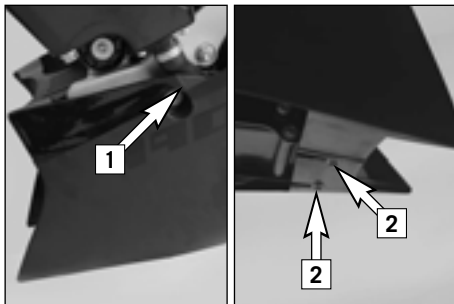

Removing and remounting the battery

The battery only needs to be removed if the motorcycle is being immobilized.

Remove the screws [1] on both sides, loosen the screws [2] 2 turns and remove the front spoiler towards the front. Push the cables to the side. Remove the screws [3] and fold the battery cover [4] down.

First disconnect the negative terminal, then the positive terminal from the battery. Make sure the battery terminals are not bent when they are removed.

Remove the battery cover and take out the battery.

Charge the battery before and after storage. Storage temperature 0 - 35°C (32 - 95°F).

When remounting the battery, position it in the battery compartment and mount the battery cover. First connect the cables on the positive terminal, then connect the negative terminal to the battery to avoid a short-circuit. Open the battery cover and fasten with 2 screws. Remount the front spoiler. Apply Loctite 243 to the screws [1] and tighten to 10 Nm.

⚠ WARNING

- If electrolyte (sulphuric acid) leaks from the battery, proceed with great care. The electrolyte can cause severe burns.
- In the case of skin contact rinse thoroughly with water.
- In the case of contact with the eyes, thoroughly rinse eyes with water for at least 15 minutes. Immediately consult a doctor.
- The battery is a closed model but can nevertheless emit explosive gases. Avoid sparks and open fire near the battery.
- Defective batteries must be stored out of the reach of children. Ensure proper disposal of discarded batteries.
- The screws on the underride protection must be secured with loctite 243 to prevent them from becoming loose.

! CAUTION

Never disconnect the battery while the engine is running. This will destroy the rectifier-regulator.

STORAGE:

If the motorcycle is being immobilized for longer periods of time, remove and charge the battery. Storage temperature 0 - 35°C (32 - 95°F), avoid direct sunlight.

Charge the battery every 3 months.

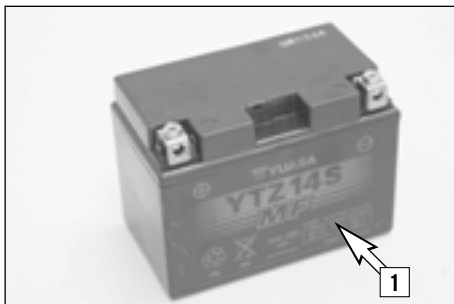

Charging the battery

The battery discharges every day, even if it is not used. Always disconnect the battery when charging. Charge the battery as described in the instructions [1] on the battery housing. Do not exceed the amperage and charging time. Quick charging at a high amperage has an adverse effect on the service life.

To charge the battery while mounted, always use the KTM battery charger (Item no. 58429074000) to ensure that the electric system is not damaged by excess voltage. **Always remove the battery if using other battery chargers!** You can also use this charging device to test the off-load voltage and startability of the battery and generator. It is impossible to overcharge the battery with this device.



Charge the battery immediately if it is empty when you start the motorcycle. If left to stand in an uncharged condition for a longer period of time, the battery will run down and sulfatize, destroying the battery.

Recharge the battery every 3 months if it is being stored for a longer period of time.

! CAUTION

- Never remove the closure since it will be damaged.
- To avoid damage to the on-board electronic system, always disconnect the minus pole before you charge the battery.
- To charge, connect the battery to the battery charger before you switch on the battery charger. When the battery is charged, switch off the battery charger before you disconnect the battery.
- Provide adequate ventilation when charging the battery in a closed room; the battery emits explosive gases when charging.
- Electrolytes will escape through the safety valves if the battery is charged too long or at an excessive voltage or amperage. This will reduce battery capacity.
- Try to avoid quick charges.

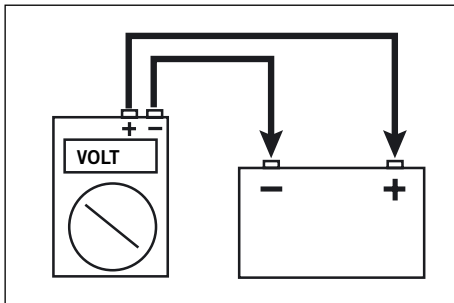

Jump start

Jump starts are not recommended since they can damage the motorcycle's electronic system.

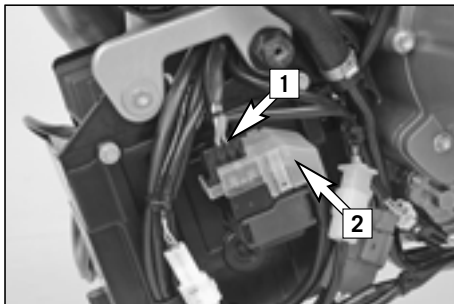

Main fuse

The main fuse protects all of the motorcycle's electric power consumers. The main fuse is located on the left under the front spoiler.

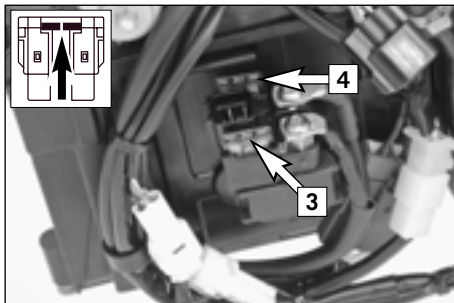

Pull the connector [1] out of the bracket, remove the cap [2] and check the main fuse [3]. A spare fuse [4] (30 amperes) is also plugged into the bracket.

Always replace blown fuses with an equivalent fuse. Visit an authorized KTM workshop if a new fuse blows again after it is inserted.

! CAUTION

Never use a stronger fuse or a repaired fuse. Improper use can destroy the entire electric system.

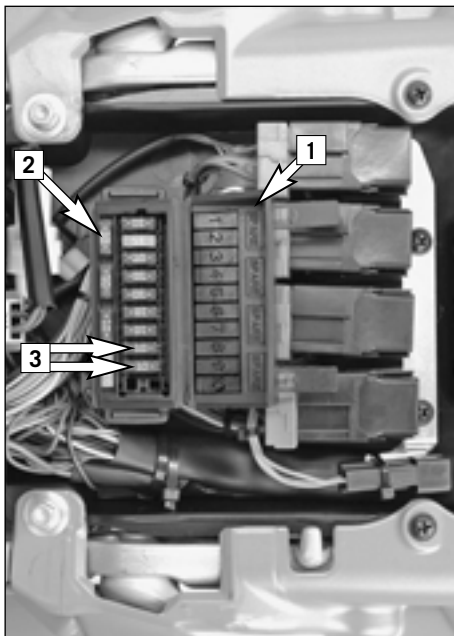

Fuses for individual power consumers

A fuse box is mounted under the seat containing additional fuses that protect the individual electric power consumers.

The power consumers are listed numerically on the cover of the fuse box [1] and allocated as described below. Spare fuses [2] with 10 and 15 amperes are also found in the fuse box.

NO	CONSUMER	AMPERES
1	Ignition	10
2	Light (high beam, low beam, parking light)	15
3	Horn, brake light, combined instrument	10
4	Fuel pump	10
5	Fan	10
6	Main relay	10
7	Clock	10
8	ACC2 for attachments (positive supply)	10
9	ACC1 for attachments (switched with the ignition)	10
10	–	
SPARE	Spare fuses	10, 15

Replace a blown fuse only with an equivalent one. If a new fuse that has just been set in gets blown again, you are strongly advised to have it inspected by a KTM dealer.

! CAUTION

Under no circumstances is a stronger fuse allowed to be set in or a fuse allowed to be “repaired”. An inexperienced treatment could damage the whole electrical installation!

The ACC1 and ACC2 fuses [3] are designed for attachments with a maximum power consumption of 10 amperes. The respective connector for this equipment is located in the headlight mask. Ask your authorized KTM workshop for details.

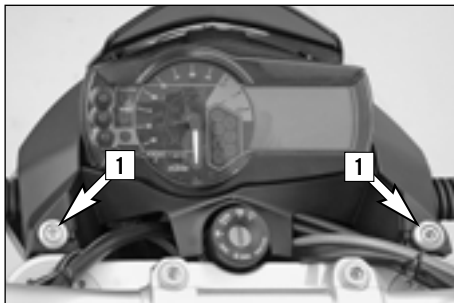

Replacing the headlight lamp

Remove the screws [1] on the left and right and tilt the headlight mask down towards the front.

! CAUTION

Never touch the glass of the bulb with your fingers. The glass of the bulb must remain absolutely free from grease. Heat will otherwise cause the grease to evaporate and settle down on the reflector.

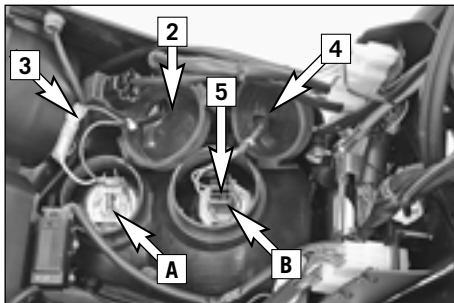

BULB FOR HIGH BEAM [A]:

Remove the rubber cap [2] and pull off the connector [3]. Detach the retaining clip and remove the bulb.

Insert a new bulb, attach the retaining clip, connect the connector and mount the rubber cap.

BULB FOR LOW BEAM [B]:

Remove the rubber cap [4] and pull off the connector [5]. Detach the retaining clip and remove the bulb.

When you insert the new bulb, make sure the tab fits in the corresponding recess in the socket.

Attach the retaining clip, connect the connector to the bulb and mount the rubber cap.

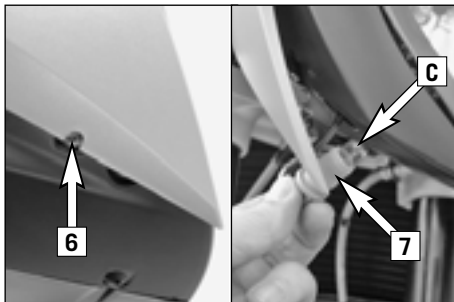

PARKING LIGHT BULB [C]:

Loosen the AH screw SW4 [6] and push the right mask spoiler aside. Pull out the bulb socket [7] and pull the light bulb out of the socket.

Mount the light bulb in the reverse order.

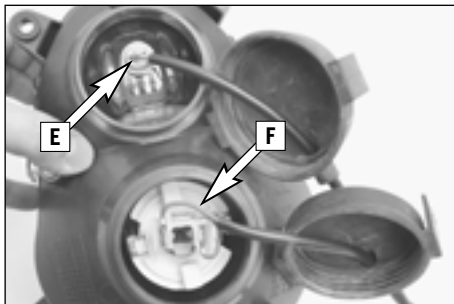

USA design:

The parking light [E] is located in the upper part of the headlight in the USA design. Bulb [F] (see Technical specifications – Chassis / Lighting) with high and low beams is mounted in the lower part of the headlight.

Connect the connectors to the connector support to check all of the bulbs for proper functioning before you remount the headlight.

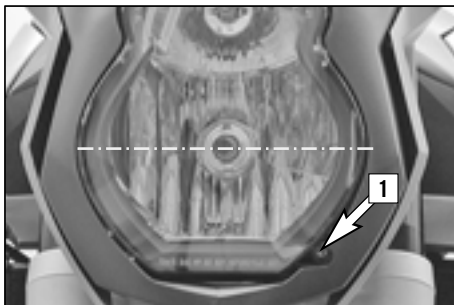

Adjusting the headlight range

The payload can make it necessary to correct the headlight range.

The headlight range can be adjusted with the adjusting screw [1]. Turning in a clockwise direction will increase the headlight range, turning in a counterclockwise direction will reduce the headlight range.

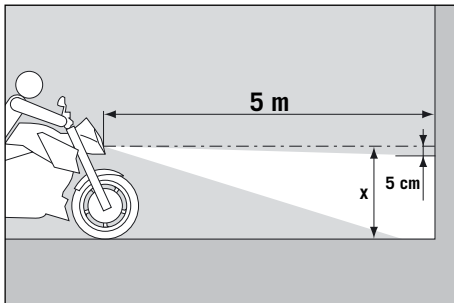

CONTROL:

Make a mark on a light colored wall behind a horizontal surface, at the height corresponding to the center of the headlight. Position your motorcycle 5 meters (16.4 ft) from the wall in a fully loaded condition (baggage, driver, passenger) and switch on the low beam. The light/dark cut-off should be 5 cm (2 in) under the mark (see drawing).

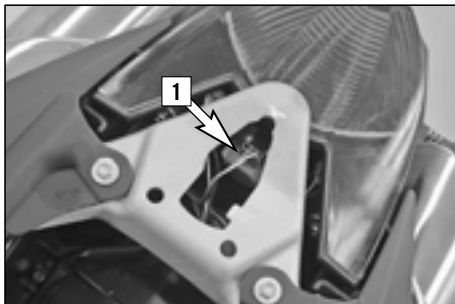

Replacing the brake light and taillight bulbs

NOTE:

Only mount red light bulbs in a smoked brake tail light.

Remove the seat.

BULB FOR BRAKE LIGHT:

Turn the bulb socket [1] approx. 30° in a counterclockwise direction and pull it out of the taillight housing. Slightly press in the bulb, turn approx. 30° in a counterclockwise direction and remove it from the socket.

Proceed in the reverse order to mount a new bulb.

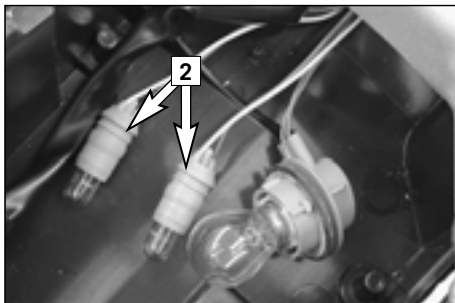

BULB FOR THE TAILLIGHT:

Remove the bulb socket [2] from the housing and pull the bulb out of the socket. Insert a new bulb and press the bulb socket all the way into the taillight housing.

Mount the seat.



Replacing the flasher bulbs

Remove the screw on the back of the turn signal, carefully fold the lens [3] towards the motorcycle and remove.

Slightly depress the bulb, turn it approx. 30° counterclockwise and pull it out of the socket.

To mount the lamp reverse the worksteps indicated above.

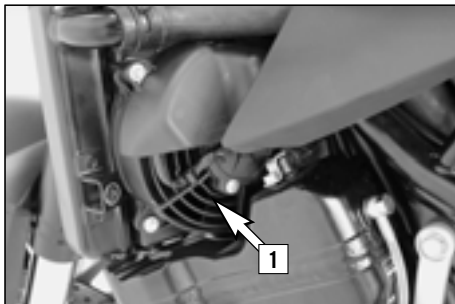

Cooling system

The water pump in the engine ensures a forced circulation of the cooling liquid. When the engine is cold, the cooling liquid only circulates in the cylinders and cylinder heads. The thermostat will open when the engine reaches approx. 75°C (167°F) and the cooling liquid will also be pumped through the aluminum radiator.

Cooling is by means of the air stream. The lower the speed, the lower the cooling effect. Soiled cooling fins also impair the cooling effect.

If, for example, slow urban traffic or waiting at a traffic light cause little or no air to stream through the radiator, the temperature of the cooling liquid will rise. The radiator fan [1] switches on when the cooling liquid reaches a temperature of 102°C (216°F). Additional air is blown through the radiator to prevent the cooling system from overheating.

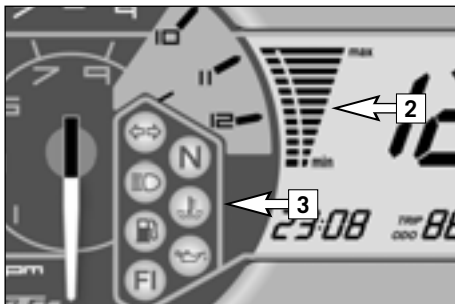

! CAUTION

The temperature indicator [2] will begin to blink and the red cooling liquid temperature warning lamp [3] will light up when the cooling liquid reaches approx. 120°C (248°F), having exceeded the normal operating temperature. Possible causes:

- Slow riding with large loads at a higher air temperature:
If possible increase your running speed, so that more air can blow through the radiators. Should the warning light still be on off after 1500 meters (1 mile), stop immediately, switch off the engine and look for other possible causes.
- The cooling fan on the radiator is not working:
The cooling fan must be running, when the cooling liquid temperature is 120°C (248°F) and the ignition is on. If the fan is not working, and there appears to be sufficient cooling liquid, the only thing you can do is to drive on to your nearest authorized KTM workshop at the least possible engine load.
- Too little cooling liquid in the system:
Check whether any cooling liquid is leaking out (also on the bottom of the motorcycle). Let the engine cool down and check the cooling liquid level in the radiator (see chapter Checking the cooling liquid level in the radiator). Only continue to drive if there is enough cooling liquid in the system. Contact an authorized KTM workshop to have the error eliminated. You will damage the engine if you continue to drive when the cooling liquid temperature warning lamp is on.
- Excessive use of the clutch at slow speed



A mixture of 50% antifreeze and 50% distilled water is used as the cooling liquid. However, the anti-freeze protection must be at least -25°C (-13°F). Aside from antifreezing protection, this mixture also provides great corrosion protection which is why it must not be replaced by pure water.

! CAUTION

- For the cooling system, use only high-grade antifreezer (Motorex Anti-Freeze). Using lowergrade antifreeze agents, can cause corrosion and coolant foaming.
- More antifreeze must be added if you plan to travel to a region where temperatures are expected to drop below -25°C (-13°F).

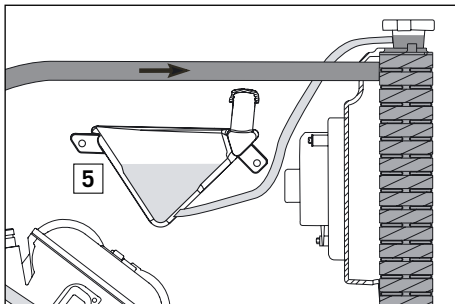

Pressure induced by heating of the cooling liquid in the cooling system is controlled by a valve in the radiator cap [4]; a water temperature rising up to 125°C (257°F) is admissible, without fear of problems. Any excess cooling liquid caused by thermal expansion is conducted to the compensating tank [5]. It will be sucked back in as soon as the temperature in the cooling system drops.

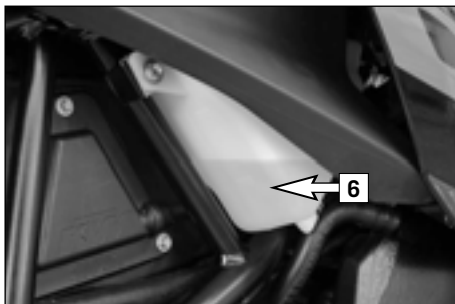

Checking the cooling liquid level in the compensating tank

Check the level of the cooling liquid when the engine is cold. It should fall between the MIN and MAX marks on the compensating tank [6].

Add cooling liquid (see above for mixture ratio) if the cooling liquid level drops below the MIN mark.

If you need to add cooling liquid quite often, the cooling system may leak. If the compensating tank is empty, also check the cooling liquid level in the radiator. Have the cooling system checked by an authorized KTM workshop.

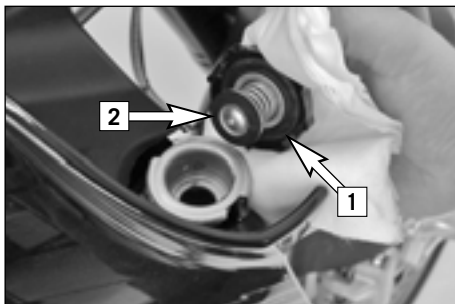

Checking the cooling liquid level in the radiator

Hold the radiator cap [1] with a cloth, carefully turn in a counterclockwise direction and remove. The radiator should be completely filled with cooling liquid; no air should be in the radiator.

If any cooling liquid is missing, the cooling system is probably leaking. Have the cooling system checked at an authorized KTM workshop.

WARNING

If possible, check the cooling liquid level when the engine is cold. If you need to remove the radiator cap when the engine is hot, hold the cap with a cloth and open slowly, allowing any excess pressure to escape (danger of scalding).

CAUTION

- Accumulated soil and lime on the radiator cap will cause you to lose cooling liquid. Carefully clean the radiator cap, gasket [2] and sealing area each time.
- If more than 1 liter of cooling liquid needs to be added, you will need to bleed the cooling system.

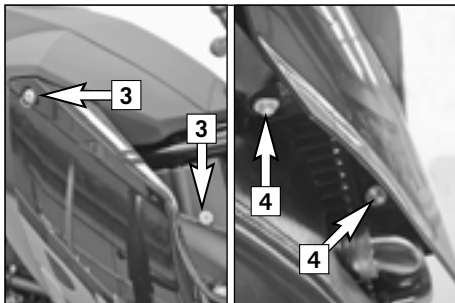

Bleeding the cooling system

Take off the left and right spoilers. To take off the spoilers, remove the screws [3] and [4] on each side.

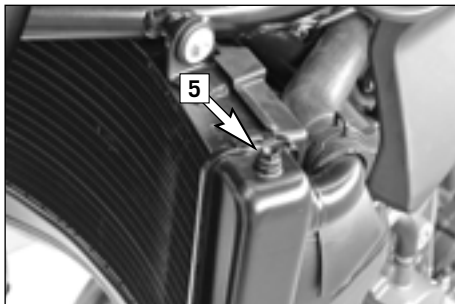

Remove the bleeder screw [5] on the left side of the radiator.

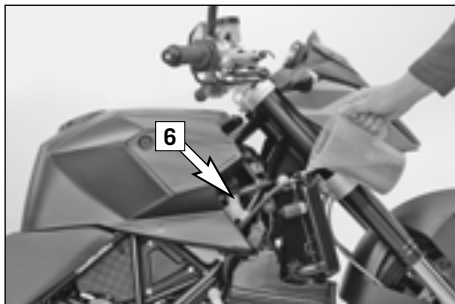

To completely bleed the cooling system, the motorcycle must be raised approx. 50 cm (20 in) in the front.

Add cooling liquid until it runs out of the vent holes without bubbles and immediately mount the screw to prevent air from entering the radiator.

Completely fill the radiator with cooling liquid. Mount the radiator cap and move the motorcycle into a horizontal position again. Now fill the compensating tank [6] with cooling liquid until it reaches a level between the MIN and MAX marks. Close the compensating tank and mount both spoilers.

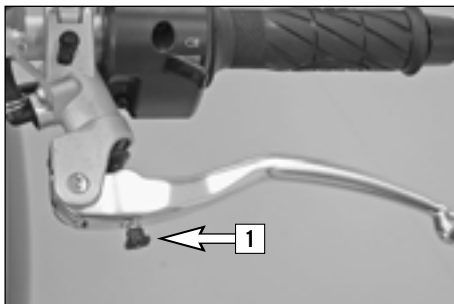

Changing the basic position of the clutch lever

The basic position of the clutch lever can be modified by turning the adjusting screw [1]. This lets you adjust the best clutch lever position for any hand size.

To adjust, pull the clutch lever towards the front. Turning the adjusting screw in a clockwise direction will move the clutch lever away from the driver. Turning the adjusting screw in a counterclockwise direction will move the clutch lever towards the driver.

! CAUTION

Adjustment of the clutch lever position is only possible within certain limits. Only turn the adjusting screw manually and never apply excessive force.



Checking the oil level of the hydraulic clutch

The oil level should be between the „MIN“ and „MAX“ marks with the master cylinder in a horizontal position.

If necessary, add SAE 10 biodegradable hydraulic oil (Motorex clutch fluid 75), available from your authorized KTM workshop.

! CAUTION

KTM uses biodegradable, hydraulic mineral oil to actuate the hydraulic clutch. Do not mix this oil with any other hydraulic oil. Always use original KTM hydraulic oil (available from your authorized KTM workshop) to make sure your clutch operates smoothly. Never refill with brake fluid.

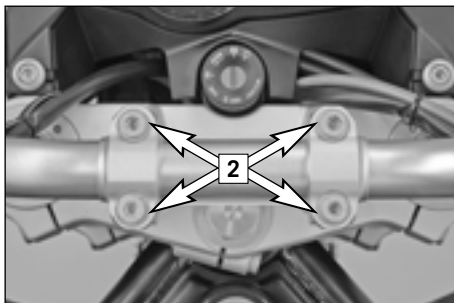

Adjusting the handlebar tilt

Loosen the screws [2]. Adjust the handlebar and tighten the screws to 20 Nm.

Make sure the handlebar instruments do not touch the fuel tank when the handlebar is completely turned.

⚠ WARNING

Tilting the handlebar too far back will reduce the steering angle since the handlebar instruments will touch the fuel tank

! CAUTION

If the handlebar is tilted too far back, the handlebar instruments may damage the fuel tank.

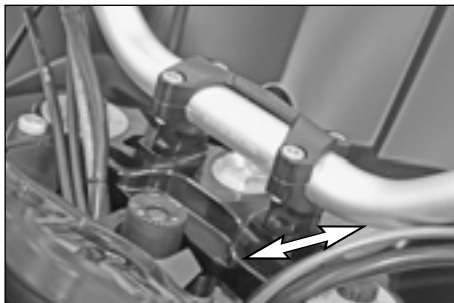

How to change the handlebar position (Super Duke R)

The upper triple clamp includes 2 bores arranged at a distance of 15 mm (0.6 in) from one another. Accordingly, you can mount the handlebar in 2 different positions.

! CAUTION

The steering angle is reduced if the handlebar is mounted in the rear position. Adjust the steering lock so it does not hit the fuel tank.

Tighten M10 screws to 45 Nm and M8 screws to 20 Nm.

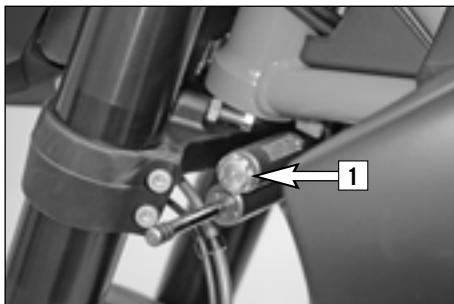

Adjusting the steering damper (Super Duke R)

The steering damper stabilizes the steering whenever the front wheel is relieved or off the ground. The damping degree can be adjusted to harder (+) or softer (-) damping by turning the adjusting knob [1].

BASIC SETTING

- Turn the adjusting knob all the way to the stop in a clockwise direction
- Turn 15 clicks in a counterclockwise direction

Only change the setting by 3 clicks at a time and take a test ride.

⚠ WARNING

- **Always check the steering for smooth operation before starting off on a ride.**
- **Do not try to adjust the steering damper while driving. Your attention will be distracted from the traffic and this may cause you to lose control of your motorcycle.**

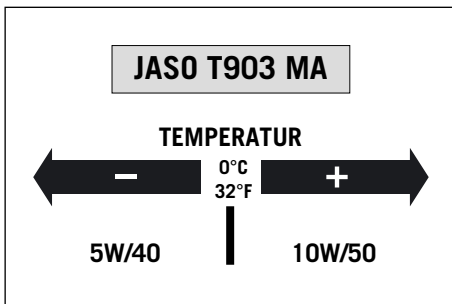

Engine oil

Automobile engine oil used to be used for four-stroke motorcycles before there were separate motorcycle specifications. Different technical developments made it necessary to have a separate specification for four-stroke motorcycles - the JASO T903 MA standard. Whereas car engines require long changing intervals, motorcycle engines require a higher power output at higher speeds. Most motorcycle engines also use the same oil to lubricate the transmission and the clutch. The JASO MA standard responds to these special requirements. Only use fully synthetic engine oils that meet the JASO MA quality requirements (see information on the can).

KTM recommends Motorex Power Synt 4T in the 10W/50 viscosity (for temperatures over 0°C, 32°F) or 5W/40 (for temperatures under 0°C, 32°F).

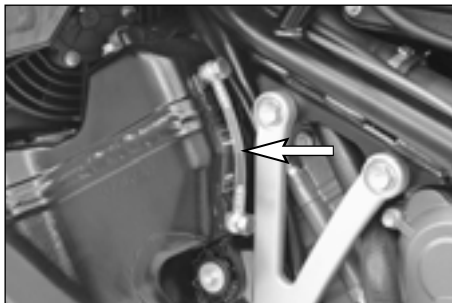

Checking the engine oil level

Check the engine oil level when the engine is warm (at least 4 bars on the temperature indicator light up). Allow the warm engine to run idle for approx. 1 minute and place the motorcycle on a level surface (not on the side stand).

Wait 20 seconds to allow the oil level in the inspection glass to adjust to the oil level in the oil tank. The oil level should be between the MIN and MAX marks, add engine oil if necessary.

! CAUTION

Always check the oil level when the engine is warm. A cold engine can distort the measuring results. Engine oil expands when heated, increasing the oil level.

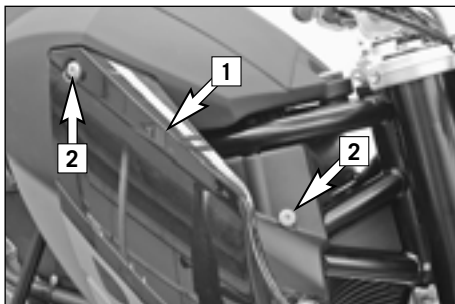

Refilling engine oil

To refill engine oil, take off the right spoiler [1] by removing the screws [2].

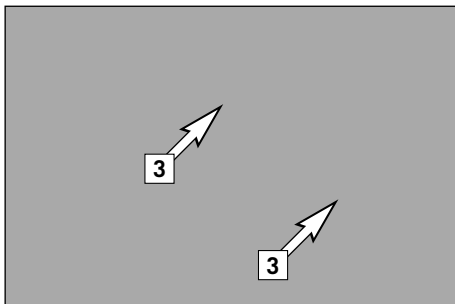

Also remove the screws [3] and take off the spoiler.

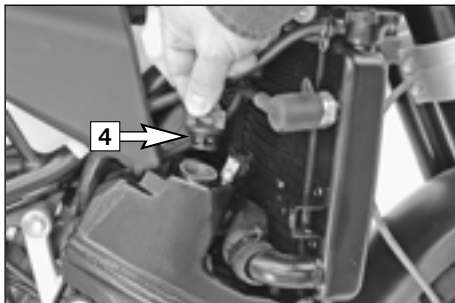

Unscrew the plug [4] and refill engine oil. Wait 20 seconds and check the oil level again. The quantity of oil between the MIN and MAX marks is 0.3 liter. Mount the plug and check the engine for leaks. Finally, mount the spoilers.

! CAUTION

- Insufficient amounts of or low-grade engine oil lead to premature wear in the engine.
- Do not overfill the engine case.
- Do not underfill the engine case.

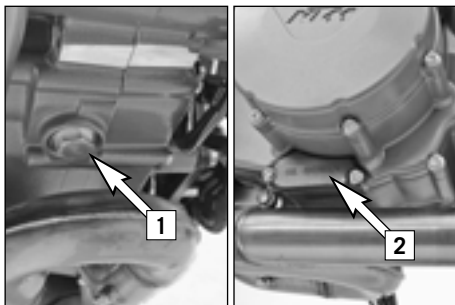

Changing the engine oil and the oil filter, cleaning the oil screen

! CAUTION

You may only change the engine oil yourself after the warranty period has expired. The warranty will become void if you change the oil yourself during the warranty period.

NOTE: The LC8 engine has a dry-sump lubrication system. The engine oil is pumped from the oil sump in the engine case to the oil tank. The engine oil must also be drained from the oil tank during an oil change. Since many parts must be demounted for an oil change, we recommend having the engine oil changed by an authorized KTM workshop. During the warranty period, the oil change must be performed by an authorized KTM mechanic. Otherwise, the guarantee will become void.

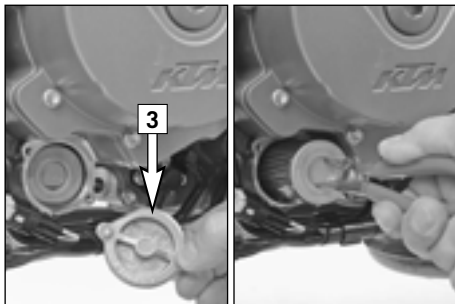

The engine oil change is to be carried out when the engine is still warm.

⚠ WARNING

An engine having been run warm, and the engine oil in it is very hot – do not burn yourself.

Park the motorcycle on an even surface in an upright position. Place a vessel under the engine to catch the used oil and remove the oil drain plug [1]. Remove the oil drain plug [1], take off the cap [2] and pull the oil sieve out of the engine case with a pair of pliers.

Remove the oil filter cover [3] and pull the oil filter out of the engine case with circlip pliers (upside-down).

Remove the screws [4], loosen the screws [5] by 2 turns and remove the front spoiler towards the front.

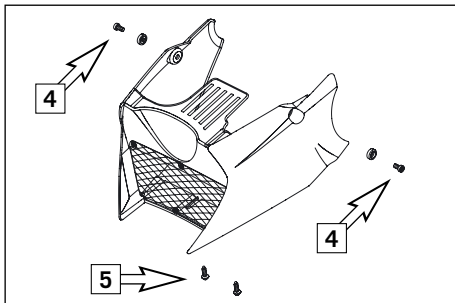

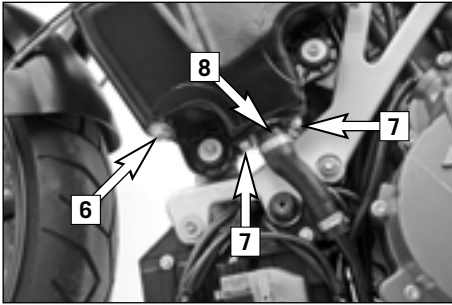

Remove the drain plug [6] on the oil tank and allow the oil to drain into a receptacle. Remove the screws [7] and tilt the oil return valve [8] to the side.

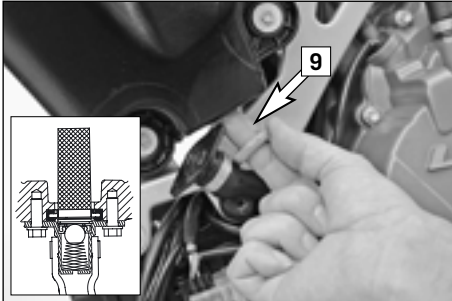

Carefully pull the oil screen [9] out of the oil tank.

Thoroughly clean the drain plugs, the cover and both oil screens. Clean all rubber seal rings and check for damage. Replace if necessary.

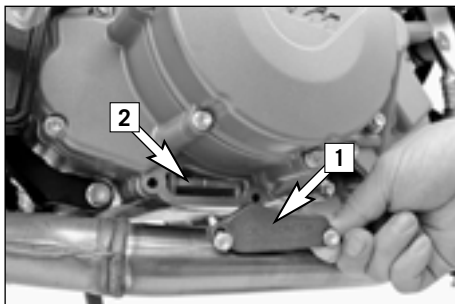

Mount the oil drain plug on the engine with a new seal ring and tighten to 20 Nm.

Slide the oil screen [1] into the guides in the oil pump housing with the TOP mark facing up. Make sure the form ring is in place and mount the cap [2]. Tighten the screws to 10 Nm.

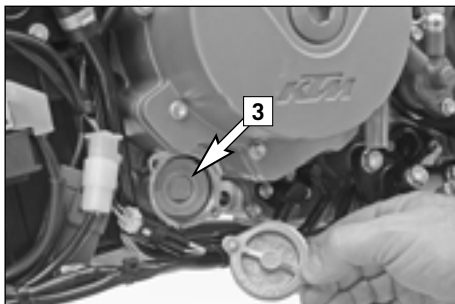

Insert a new oil filter [3] in the engine case, grease the O-ring and mount the oil filter cover together with the O-ring. Tighten the screws to 6 Nm.

! CAUTION

Only use original ktm oil filters. The engine can be damaged if other filters are used.

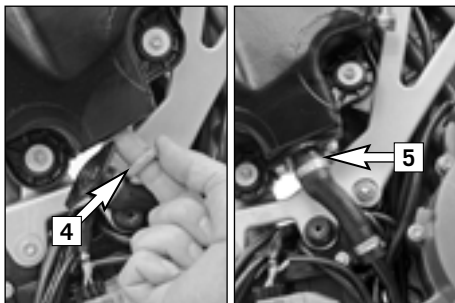

Mount the oil drain plug on the oil tank with a new seal ring and tighten to 20 Nm.

Grease the seal ring [4] and carefully slide the oil screen into the oil tank. Position the oil return valve [5], mount the screws and tighten to 10 Nm.

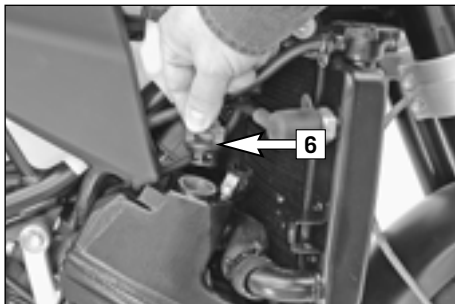

Remove the right spoiler (see Refilling the engine oil) and unscrew the plug **[6]**. Add 2.5 liters (0.7 USgal) of fully synthetic engine oil meeting the JASO MA standard (e.g. Motorex Power Synt 4T) and remount the plug. Start the engine and allow to run warm in neutral until 4 bars on the temperature indicator light up. Switch off the engine and check the oil level (see Checking the engine oil level).

Check the engine and the oil tank for oil leakage.

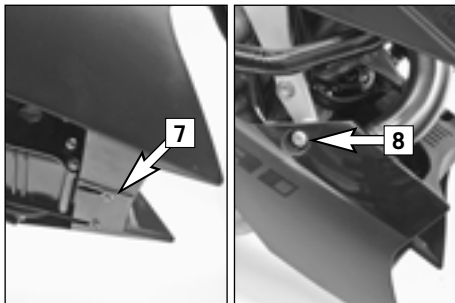

Fit the slots in the front spoiler on the lower screws **[7]** and tighten. Apply Loctite 243 to the side screws **[8]** and tighten to 10 Nm.

Finally, mount the spoiler (see Refilling the engine oil).

If you have your motorcycle serviced as set forth in this manual, no malfunctioning is to be expected. Nevertheless, if an error does arise, we recommend that you look for the error according to the following chart.

Please note that you cannot perform all of the work yourself. If you are not sure, contact your KTM dealer.

TROUBLE	CAUSE	REMEDY
Engine does not start when the starter button is actuated	Operating error	Turn on the ignition, switch the gear to neutral and switch the emergency OFF switch on, do not accelerate while starting the engine.
	Discharged battery	Recharge the battery and investigate the causes for discharging; contact an authorized KTM workshop.
	Blown fuse	Replace fuse 1
	Main fuse is blown	Remove the front spoiler and replace the main fuse
	Defect ignition lock or emergency OFF switch	Check ignition lock and emergency OFF switch, contact an authorized KTM workshop.
The engine cranks only with pulled clutch lever	A gear is engaged	Shift the transmission to neutral.
	A gear is engaged and the side stand is still folded down	Shift the transmission to neutral.
	Defect safe-starting system.	Contact an authorized KTM workshop.
Engine cranks with gear engaged.	Defect safe-starting system.	Contact an authorized KTM workshop.

TROUBLE	CAUSE	REMEDY
Engine cranks but doesn't start.	<p>Operating error</p> <p>Blown fuse for the fuel pump</p> <p>Clutch not attached to the fuel line</p> <p>The plug and socket connector on the wiring harness is oxidized</p> <p>Error in the injection system</p>	<p>Pay attention to starting off information (see driving instructions).</p> <p>Replace fuse 4</p> <p>Connect the clutch to the fuel line</p> <p>Remove the panel and fuel tank, clean the plug and socket connector and spray with contact spray</p> <p>Visit an authorized KTM workshop</p>
Engine will not reach full power	<p>Air filter/fuel filter heavily soiled</p> <p>Error in the injection system</p>	<p>Have the air filter/fuel filter replaced at an authorized KTM workshop</p> <p>Visit an authorized KTM workshop</p>
Engine overheats	<p>Insufficient cooling liquid</p> <p>Radiator fins are extremely dirty</p> <p>Foam forms in cooling system</p> <p>Radiator hose is kinked or damaged</p> <p>Thermostat defective</p>	<p>Refill cooling liquid (see maintenance work), check cooling system for leaks</p> <p>Clean radiator with water jet</p> <p>Replace cooling liquid, use antifreezer with brand name</p> <p>Run the radiator hose correctly or replace</p> <p>Have the thermostat checked (opening temperature 75°C, 167°F) or replaced; contact an authorized KTM workshop</p>

TROUBLE	CAUSE	REMEDY
Engine overheats	Blown fan fuse	Replace fuse 5
	Defect fan or thermostwitch for fan	Contact an authorized KTM workshop.
	Air in the cooling system	Bleed the cooling system (see Maintenance work)
FI lamp is blinking / lights up	Error in the injection system	Visit an authorized KTM workshop
Engine stalls while driving	No fuel	Refuel
	Fuse for fuel pump has blown	Replace fuse 4
High oil consumption	Engine oil level too high	Check engine oil level when the engine is warm; correct if necessary
	Engine oil too thin (viscosity)	Use thicker engine oil; see chapter „Engine oil“
Headlight and position light fail	Blown fuse	Replace fuse 2
Flasher lights, brake light, horn and combined instrument fail	Sicherung durchgeschmolzen	Replace fuse 3
Time is not displayed or not correctly displayed	Blown fuse, thus no continuous power supply	Replace fuse 7 and set the clock.

TROUBLE	CAUSE	REMEDY
The battery is discharged	The ignition (power consumer) hasn't been switched off	Recharge the battery according to the relevant instructions.
	The battery isn't charged by the generator	Voltage regulator and generator should be checked by an authorized KTM workshop.
No values are visible in the combined instrument display.	Blown fuse	Replace fuse 3
The speed indication on the combined instrument is not working	Pickup cable is damaged or contacts on the cable connector have oxidized	Check the pickup cable for damage, visit an authorized KTM workshop

The blink code indicates which component is affected by an error. This allows the error to be identified if no diagnosis tool is available.

BLINK CODE	SIGNAL / COMPONENT	ERROR DESCRIPTION	ENGINE
02	Pulse generator	Malfunction	Stalls
06	Throttle sensor	Output signal too low /high	Continues to run
07	Sensor for 2nd throttle valve	Output signal too low /high	Continues to run
09	Intake manifold air pressure for sensor rear cylinder	Output signal too low /high	Continues to run
11	Intake manifold air pressure sensor for front cylinder	Output signal too low /high	Continues to run

The blink code indicates which component is affected by an error. This allows the error to be identified if no diagnosis tool is available.

BLINK CODE	SIGNAL / COMPONENT	ERROR DESCRIPTION	ENGINE
12	Coolant temperature sensor	Output signal too low /high	Continues to run
13	Air temperature sensor	Output signal too low /high	Continues to run
14	Ambient air pressure sensor	Output signal too low /high	Continues to run
15	Tilt angle sensor	Output signal too low /high	Continues to run
17	Lambda probe for rear cylinder	Malfunction	Continues to run
18	Lambda probe for front cylinder	Malfunction	Continues to run
24	Control unit voltage supply	Malfunction	Continues to run
25	Side stand switch	Short circuit to ground	Continues to run
33	Injection nozzle for rear cylinder	Malfunction	Stalls
34	Injection nozzle for front cylinder	Malfunction	Stalls
37	Ignition coil for rear cylinder	Malfunction	Stalls
38	Injection coil for front	Malfunction	Stalls
41	Fuel pump relay	Short circuit to ground / positive	Stalls
45	Lambda probe heater for rear cylinder	Short circuit to ground / positive	Continues to run
46	Lambda probe heater for front cylinder	Short circuit to ground / positive	Continues to run
49	Idle control motor	Malfunction	Continues to run
53	Purge valve for carbon canister	Short circuit to ground / positive	Continues to run
54	Secondary air valve	Short circuit to ground / positive or interruption	Continues to run
65	EEPROM error	Malfunction	Continues to run
68	Vacuum hose for front cylinder is defective	Malfunction	Continues to run
69	Vacuum hose for rear cylinder is defective	Malfunction	Continues to run
72	Stepper motor for 2nd throttle valve	Malfunction	Continues to run

Regular cleaning and paintwork care are part of the maintenance work and help to maintain the value of your motorcycle.

! CAUTION

Never clean the motorcycle with a power washer or a strong water jet, otherwise the pressure will allow water to enter the electric components, plugs, cables, bearings, etc. which can cause malfunctioning or can lead to premature wear of these components.

- Before you wash your motorcycle, close the muffler openings.
- Use warm water with a commercial detergent and sponge. Coarse dirt can be removed with a soft water jet. Areas that are heavily soiled can be sprayed with a motorcycle cleaner (e.g. Motorex 900) and cleaned with a brush.
- After the motorcycle has been rinsed with a soft water jet, it should be dried by air pressure and a cloth. Then take a short drive until the engine has reached the working temperature and also use the brakes. Due to the heat, the water also evaporates at the unapproachable parts of the engine and the brakes.
- After the motorcycle has cooled down, oil or lubricate all of the friction bearings and bearing positions and treat the chain with chain spray. Treat all bare areas (except brake disks) with a corrosion inhibitor (e.g. Motorex Protect & Shine).
- The exhaust pipes and mufflers are made of stainless steel and should be treated with a suitable care product.
- To prevent failures in the electric system, you should treat the ignition lock, the emergency OFF switch, light switch and the socket connectors with contact spray.
- Treat all of the painted parts with a mild paint care product (e.g. Motorex Moto Polish).

CONSERVATION FOR WINTER OPERATION »

In the event that the motorcycle is also used in winter and on roads where one has to expect salt spraying, you will have to take precautions against the aggressive road salt.

- clean motorcycle thoroughly and let it dry
- treat engine, swing arm, and all other bare parts (except for brake discs) with a wax-based anti-corrosion agent.

⚠ WARNING

Keep anti-corrosion agent from getting into contact with the brake discs, for otherwise this will significantly reduce the braking power.

! CAUTION

After rides on salted roads, clean motorcycle thoroughly with cold water and let it dry well!

If you plan to immobilize your motorcycle for a longer period of time, proceed as follows:

- Run the tank empty to be able to add fresh fuel when starting up again.
- Clean the motorcycle thoroughly (see CLEANING chapter).
- Change the engine oil and the oil filter (old engine oil contains aggressive impurities).
- Check the quantity of antifreeze and cooling liquid.
- Remove and charge the battery (see Charging the battery chapter).
- If possible, jack up the motorcycle to lift the wheels off the ground.
- The storage site should be dry and not subject to larger temperature fluctuations.
- Cover the motorcycle with a permeable cover or blanket. Do not use impermeable material since it will not allow and moisture to escape and will cause corrosion.

! CAUTION

Do not briefly run the engine of an immobilized motorcycle since the engine will not become warm enough and any vapor produced during the combustion process will condense and cause the valves and exhaust to rust.

STARTING UP AFTER IMMOBILIZATION

- Mount the charged battery (pay attention to the polarity) and set the clock.
- Fill fresh fuel in the tank.
- Inspect the motorcycle as you would before each start-up (see „Driving Instructions“).
- Go on a short, cautious test ride

NOTE: before you store your motorcycle at the end of the season, check all parts for proper functioning and wear. If service, repairs or conversions are necessary, have them carried out while the motorcycle is immobilized (workshops are not fully utilized). This will help to avoid long waiting periods at the beginning of the season.

CHASSIS	990 SUPER DUKE / R 2008
Frame	Tubular chrome-molybdenum-steel space frame
Fork	WP Suspension – Up Side Down 4860 ROMA
Spring travel front	135 mm (5.3 in)
Rear suspension	WP Suspension 4618 BAVP
Spring travel rear	Super Duke: 160 mm (6.3 in) Super Duke R: 150 mm (5.9 in)
Front brake	Disk brake, 2 perforated brake disks Ø 320 mm (12.6 in), brake calipers radially bolted
Rear brake	Disk brake, perforated brake disk Ø 240 mm (9.4 in), floating brake caliper
Authorized front tires *	DUNLOP Sportmax D208 RR 120/70 ZR17 M/C 58W
Air pressure front	Road, driver only.....2.4 bar Road, with passenger / maximum payload2.4 bar
Authorized rear tires *	DUNLOP Sportmax D208 RR 180/55 ZR17 M/C 73W
Air pressure rear	Road, driver only.....2.4 bar Road, with passenger / maximum payload2.6 bar
Fuel tank capacity	18.5 liters (4.9 USgal), 3.5 (0.9 USgal) liters Reserve
Gear ratio – rear wheel	16:38
Chain	5/8 x 5/16" X-ring
Lighting	high beamH3 12V 55W (socket PK22s) low beamH7 12V 55W (socket PX26d) USA: high beam + low beamH4 12V 60/55 W (socket P43t) position light front12V 5W (socket W2,1x9,5d) indicator lampsLED position light rear12V WR5W (socket W2,1x9,5d)Super Duke R: LED USA: position light rear12V 5W (socket W2,1x9,5d)Super Duke R: LED stoplight12V PR21W (socket BAW15s)Super Duke R: LED USA: stoplight12V 21W (socket BA15s)Super Duke R: LED flashers12V RY10W (socket BAU15s) licens plate illumination12V 5W (socket W2,1x9,5d)

* further tire releases are available on the Internet at www.ktm.com

CHASSIS	990 SUPER DUKE / R 2008	
Battery	maintenance-free battery 12V 11.2 Ah	
Steering head angle	Super Duke: 66.1°	Super Duke R: 67.3°
Wheel base	1450 ± 10 mm (57 ± 0.4 in)	
Seat height, unloaded	Super Duke: 850 mm (33.5 in)	Super Duke R: 860 mm (33.9 in)
Ground clearance, unloaded	Super Duke: 140 mm (5.5 in)	Super Duke R: 150 mm (5.9 in)
Dry weight	186 kg (410.6 lbs)	
Max. axle load front	180 kg (397.3 lbs)	
Max. axle load rear	250 kg (551.8 lbs)	
Max. total load	387 kg (854.2 lbs)	

BASIC SETTING FORK WP 4860 ROMA	Super Duke				Super Duke R			
	Driving Comfort	Basic Setting	Driving Sport	Maximum Payload	Basic Setting	Driving Sport	Race course	Maximum Payload
Compression adjuster (clicks)	20	15	10	10	18	18	14	18
Rebound adjuster (clicks)	20	15	10	10	16	16	12	16
Spring preload (turns)	5	5	5	5	5	5	5	5
Spring	9.5 N/mm				9.5 N/mm			
Air chamber length	110 mm (4.3 in)				80 mm (3.5 in)			
Fork oil	SAE 5 (WP 4860.0401)							

BASIC SETTING SHOCK ABSORBER WP 4618 BAVP	Super Duke				Super Duke R			
	Driving Comfort	Basic Setting	Driving Sport	Maximum Payload	Basic Setting	Driving Sport	Race course	Maximum Payload
Compression adj. Low Speed (clicks)	25	20	10	10	20	16	10	16
Compression adj. High Speed (turns)	2	1.5	1	1	2.5	1.5	1	1.5
Rebound adjuster (clicks)	20	12	8	8	12	12	8	12
Spring preload (mm)	6	6	6	6	5	5	5	5
Spring	170/185				180/185			

TIGHTENING TORQUES – CHASSIS 2008		
Collar bolt on front wheel spindle	M24x1.5	60 Nm
Collar nut wheel spindle rear	M25x1.5	90 Nm
AH bolt shock absorber top/bottom	M14x1.5	80 Nm
Collar nut for swing arm bolt	M19x1.5	130 Nm
AH bolts on subframe	M8	Loctite 243 + 25 Nm
AH bolts on back of footrest support	M8	Loctite 243 + 25 Nm
Engine carrier bolts	M10	45 Nm
HH clamp bolts on top triple clamp	M8	12 Nm
HH clamp bolts on bottom triple clamp	M8	15 Nm
HH screw for steering head	M20x1.5	12 Nm
HH clamp bolts on fork leg axle passages	M8	15 Nm
Collar bolts for handlebar clamps	M8	20 Nm
AH bolt for handlebar mount (Super Duke)	M10	20 Nm
AH bolt for handlebar mount (Super Duke R)	M10	45 Nm
HH clamp bolts for steering stem	M8	20 Nm
Collar bolt front/rear brake disk	M8x1.25	Loctite 243 + 30 Nm
HH bolts on front brake caliper	M10x1.25	Loctite 243 + 45 Nm
HH bolts on handbrake cylinder	M6	10 Nm
HH bolts on footbrake cylinder	M6	Loctite 243 + 10 Nm
AH bearing bolt for foot brake pedal, shift lever	M8	Loctite 243 + 25 Nm
HH screw on cover plate for foot brake lever/shift mechanism	M6	Loctite 243 + 2 Nm
Relay for shift shaft (on connecting support)	M8	Loctite 243 + 25 Nm
Relay for shift shaft (on shift shaft)	M6	Loctite 243 + 18 Nm
Gearshift rod attachment	M6	Loctite 243 + 12 Nm
HH bolts on foot brake pedal surface	M5	Loctite 243 + 6 Nm

TIGHTENING TORQUES – CHASSIS 2008		
AH bolts for side stand bracket - engine	M10	Loctite 243 + 45 Nm
HH bolts for side stand fixture - side stand bracket	M10	Loctite 243 + 25 Nm
HH bolts for side stand mounting	M10	Loctite 243 + 35 Nm
HH bolt for spring rest on side stand	M8	Loctite 243 + 25 Nm
HH bolt for side stand switch	M4	Loctite 243 + 2 Nm
Drain plug on oil tank	M12x1.5	25 Nm
Exhaust nuts on manifold	M8	evenly, do not bend sheet metal
Exhaust clamps	M8	8 Nm
Exhaust clamps for ball joint	M8	35 Nm
AH bolts on tank cover	M5	5 Nm
HH bolts on tank mounting	M6	6 Nm
Collar screws for in-tank pump	M6	6 Nm
AH screw on arm for tank support	M10	15 Nm
Collar screw for gas pressure shock absorber	M6	6 Nm
Seat fixing plate	M5	4 Nm
HH nut for seat lock	M19x1	8 Nm
Jerk damper bolt - rear wheel	M10x1.25	Loctite 243 + 50 Nm
Chainguard	M5	5 Nm
Chain sliding guard	M5	Loctite 243 + 6 Nm
Front spoiler	M6	Loctite 243 + 10 Nm
Taillight	M6	8 Nm
Screw, steering damper, fork leg clamp (Super Duke R)	M8	Loctite 243 + 10 Nm
Screw, steering damper, top triple clamp (Super Duke R)	M8	Loctite 243 + 10 Nm
Screw, steering damper, piston rod (Super Duke R)	M8	Loctite 243 + 10 Nm
Screw, steering damper, clamp (Super Duke R)	M6	Loctite 243 + 4 Nm

TIGHTENING TORQUES – CHASSIS 2008		
Other bolts on chassis	M6	10 Nm
	M8	25 Nm
	M10	45 Nm
Other collar nuts on chassis	M6	15 Nm
	M8	30 Nm
	M10	50 Nm

ENGINE	990 SUPER DUKE 2008	990 SUPER DUKE R 2008
Design	Liquid-cooled, 2-cylinder 4-stroke engine with 75° V arrangement with balancer shaft and electric starter	
Displacement	999 cc	
Bore / Stroke	101/62.4 mm	
Compression ratio	11.5:1	12.2:1
Fuel	unleaded fuel with at least RON 95 (USA: Premium RON 91) *	
Valve timing	4 valves controlled over bucket tappet and 2 camshafts, camshaft drive with gears/chain	
Valve diameter	Intake: 38 mm Exhaust: 33 mm	Intake: 41 mm Exhaust: 33 mm
Valve clearance, cold	Intake: 0.10 - 0.15 mm Exhaust: 0.25 - 0.30 mm	
Crankcase bearing	Friction bearings (2 main bearings / 1 supporting bearing)	
Conrod bearing	Friction bearing	
Piston pin bearing	Dual-fuel bearing	
Piston	Light alloy – forged	
Piston rings	1 compression ring, 1 taper face ring, 1 single-piece oil scraper ring with spiral-type expander	
Engine lubrication	Dry sump with 2 trochoidal pumps (pressure pump and suction pump)	
Engine oil	SAE 10W-50 (Motorex Power Synt 4T) #	
Quantity of engine oil	approx. 3 liters (0.8 USgal) during oil/filter change	
Primary drive	Straight-toothed spur wheels 35 : 67	
Clutch	Multi-disc clutch in oil bath	
Transmission	6-speed claw shifted	
Gear ratio	1 st gear 14:36 2 nd gear 16:30 3 rd gear 20:30 4 th gear 21:27 5 th gear 23:26 6 th gear 25:26	

ENGINE	990 SUPER DUKE 2008	990 SUPER DUKE R 2008
Ignition system	breakerless transistorized electronic ignition system with digital ignition advance	
Ignition timing	Map-controlled via TPS	
Map-controlled via TPS	12V 450W at 6000 rpm	
Spark plug	NGK IR KR8DI	NGK LKAR8AI-9
Electrode distance	0.8 mm	
Cooling system	liquid cooled, permanent circulation of cooling liquid through water pump	
Cooling liquid	2.1 liters (0.55 USgal), 50% antifreeze, 50% distilled water, at least -25° C	
Starting aid	electric starter	

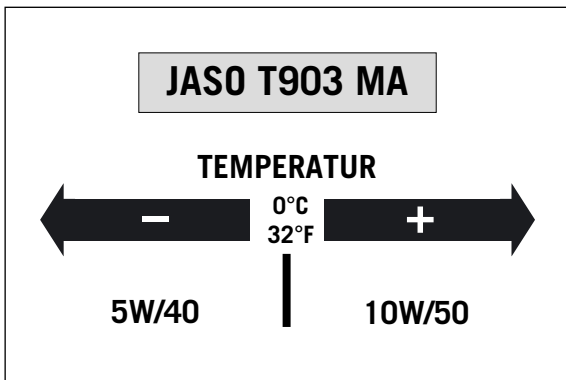

#

* PON / CLC	RON / ROZ	MON
87	91	83
91 Premium	95	87

PON = Pump Octane Number
 CLC = Cost of Living Council
 RON = Research Octane Number
 ROZ = Research Oktan Zahl
 MON = Motor Octane Number

Engine oil

Only use fully synthetic engine oils that meet the JASO MA quality requirements (see information on the can).

KTM recommends Motorex Power Synt 4T in the 10W/50 viscosity (for temperatures over 0°C, 32°F) or 5W/40 (for temperatures under 0°C, 32°F).

Accessories and payload23	Checking the rear brake pads46
Adjusting compression damping of fork37	Cleaning77
Adjusting rebound damping of fork37	Clutch lever7
Adjusting the basic position of the hand brake lever44	Combination switch14
Adjusting the fork and shock absorber37	Combined instrument8
Adjusting the handlebar tilt64	Combined instrument display8
Adjusting the headlight range58	Compression damping of fork19
Adjusting the spring preload on the fork38	Compression damping of shock absorber38
Adjusting the steering damper (Super Duke R)65	Conservation for winter operation77
Baggage loops16	Consumer information for USA only87
Battery52	Cooling liquid temperature display12
Bleeding the cooling system62	Cooling system60
Braking28	Correcting the chain tension40
Chain maintenance41	Damping action during compression of shock absorber20
Changing the basic position of the clutch lever64	Dismounting and mounting the rear wheel50
Changing the engine oil and the oil filter, cleaning the oil screen68	Dismounting and remounting the front wheel48
Changing the saet height (Super Duke R)47	Driving instructions24
Charging the battery54	Engine number, engine type6
Chassis number, Type label6	Engine oil85
Check the following before each start24	Engine oil66
Checking the chain for wear41	Filler cap15
Checking the chain tension40	Foot brake pedal18
Checking the cooling liquid level in the compensating tank61	Footrests19
Checking the cooling liquid level in the radiator62	Fuel30
Checking the engine oil level66	Function buttons on combined instrument8
Checking the front brake fluid level44	Fuses for individual power consumers56
Checking the front brake pads45	General information on KTM disk brakes42
Checking the oil level of the hydraulic clutch64	General tips and warnings for starting the motorcycle22
Checking the rear brake fluid level46	Hand brake lever7
		Helmet lock17

Holding strap17	Starting the engine26
How to change the handlebar position (Super Duke R)65	Starting up after immobilization78
Ignition lock14	Stopping and parking29
Important information2	Storage78
Index4	Tachometer12
Indicator lamps13	Technical specifications – chassis79
Instructions for initial operation22	Technical specifications – engine84
Introduction1	Tires, air pressure51
Jump start54	Tool set17
Main fuse55	Troubleshooting72
Maintenance work on chassis and engine36		
Operation instruments7		
Periodic maintenance schedule32		
Rebound damping of fork19		
Rebound damping of shock absorber39		
Rebound damping of shock absorber21		
Refilling engine oil67		
Removing and remounting the battery53		
Replacing the brake light and taillight bulbs59		
Replacing the flasher bulbs59		
Replacing the headlight lamp57		
Running in the LC8 engine22		
Seat lock, removing the seat16		
Serial number locations6		
Shift lever18		
Shifting/Riding27		
Side stand18		
Spring preload of the fork20		
Starter tip switch, Emergency OFF tip switch15		
Starting off27		

REPORTING SAFETY DEFECTS

If you believe that your vehicle has a defect which could cause an accident resulting in injury or death, you should immediately inform the National Highway Traffic Safety Administration (NHTSA) in addition to notifying KTM North America, Inc.

If NHTSA receives similar complaints, it may open an investigation, and if it finds that a safety defect exists in a group of vehicles, it may order a recall and remedy campaign. However, NHTSA cannot become involved in individual problems between you, your dealer, or KTM North America, Inc.

To contact NHTSA, you may either call the Auto Safety Hotline toll-free at 1-800-424-9393 or visit the website www.nhtsa.dot.gov, or write to: NHTSA, U.S. Department of Transportation, 400 7th Street, Southwest, Washington, D.C. 20590. You can also obtain other information about motor vehicle safety from the Hotline.

NOISE EMISSION WARRANTY

KTM Sportmotorcycle AG warrants that this exhaust system, at the time of sale, meets all applicable U.S. EPA Federal noise standards. This warranty extends to the first person who buys this exhaust system for purposes other than resale, and to all subsequent buyers.

Warranty claims should be directed to:

KTM North America, Inc. 1119 Milan Avenue, Amherst, Ohio 44001, Telephone: (440) 9853553

TAMPERING WARNING

TAMPERING WITH NOISE CONTROL SYSTEM PROHIBITED. FEDERAL LAW PROHIBITS THE FOLLOWING ACTS OR CAUSING THEREOF:

- 1) The removal or rendering inoperative by any person other than for purposes of maintenance, repair, or replacement, of any device or element of design incorporated into any new vehicle for the purpose of noise control prior to its sale or delivery to the ultimate purchaser or while it is in use, or
- 2) The use of the vehicle after such device or element of design has been removed or rendered inoperative by any person.

AMONG THOSE ACTS PRESUMED TO CONSTITUTE TAMPERING ARE THE ACTS LISTED BELOW.

- 1) Removal of, or puncturing the muffler, baffles, header pipes or any other components which conducts exhaust gases.
- 2) Removal or puncturing of any part of the intake system.
- 3) Lack of proper maintenance.
- 4) Replacing any moving part of the vehicle, or parts of the exhaust or intake system, with parts other than those specified by the manufacturer.

WARNING STATEMENT

This product should be checked for repair or replacement if the motorcycle noise has increased significantly through use. Otherwise, the owner may become subject to penalties under state and local ordinances.

CONSUMER RIGHTS

Limited Warranty claims should be directed to an authorized KTM dealer. If you are not satisfied, please contact KTM North America, Inc., Customer Relations, 1119 Milan Avenue, Amherst, Ohio 44001.

Your rights may vary, please refer to the applicable state laws.

Sticker positions:

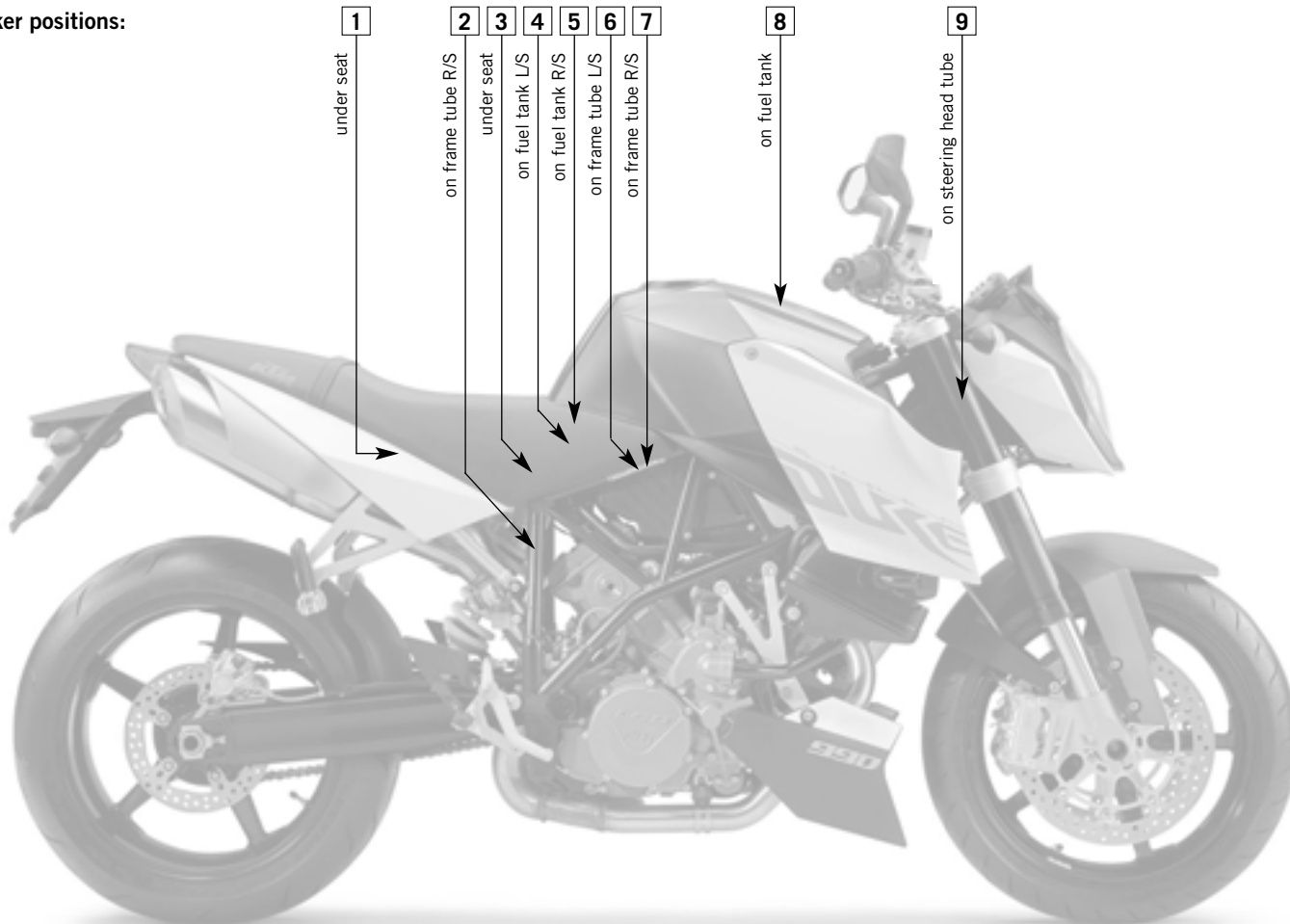

[1] EAVP

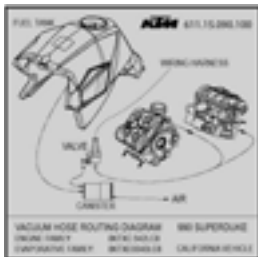

[3] Suspension setting Super Duke

611.03.497.000	FORK			SHOCK			
SETTING	Compression (click)	Rebound (click)	Spring preload (mm)	Comp. low speed (click)	Comp. high speed (mm)	Rebound (click)	
	Combat	20	20	5	25	3	20
	Basic setting	15	15	5	20	1.5	12
	Sport (or > 90kg)	10	10	5	10	1	5
Max. payload	10	10	5	10	1	5	

[3] Suspension setting Super Duke R

611.03.597.000	FORK			SHOCK			
SETTING	Compression (click)	Rebound (click)	Spring preload (mm)	Comp. low speed (click)	Comp. high speed (mm)	Rebound (click)	
	Basic setting	18	16	5	20	2.5	12
	Sport (or > 90kg)	18	16	5	16	1.5	12
	Race course	14	12	5	10	1	5

[4] Chain tension



[5] Technical information

990 SUPERDUKE	611.03.498.000
Fuel	RON95 unleaded (USA = PREMIUM RON 91)
Tyre front	120/70-17, speed index ZR
Air pressure front	rider only 2.4 bar (34 psi) max. payload 2.4 bar (34 psi)
Tyre rear	180/55-17, speed index ZR
Air pressure rear	rider only 2.4 bar (34 psi) max. payload 2.6 bar (37 psi)
Max. payload	185 kg (408lbs), max. total weight 387kg (854lbs) fully synthetic 10W/50 (SAE) under 0°C, 32°F
Further information see owners handbook	

[6] Noise emission

MOTORCYCLE NOISE EMISSION CONTROL INFORMATION
KTM SPORTMOTORCYCLE AG, AUSTRIA
THIS 2004 KTM 990 SUPERDUKE MOTORCYCLE 611.03.103.000 MEETS U.S. EPA NOISE EMISSION REQUIREMENTS OF 90 dBA AT 4250 RPM BY THE U.S. FEDERAL TEST PROCEDURE. MODIFICATIONS WHICH CAUSE THIS MOTORCYCLE TO EXCEED FEDERAL NOISE STANDARDS ARE PROHIBITED BY U.S. FEDERAL LAW. SEE OWNER'S MANUAL.
Motorcycle Type: 990 SUPERDUKE Date manufactured: 2003-05-10 VIN: VBKVA440X3M123456

[7] Vehicle emission

KTM MANUFACTURER: KTM SPORTMOTORCYCLE AG, Mattighofen, Austria	
EXPORTER: KTM NORTH AMERICA, INC., 10178 Wilson Ave., Anaheim, CA 92801	
ENGINE DISPLACEMENT	990 cc ENGINE CONTROL SYSTEM: ELECTRONIC CONTROL, SYSTEM
ENGINE MODEL	990C MOTOR NUMBER
ENGINE MODEL ONLY	990C MODEL NAME
THIS VEHICLE CONFORMS WITH U.S. EPA AND CALIFORNIA REGULATIONS APPLICABLE TO 2004 MODEL YEAR MOTORCYCLES WHICH ARE CERTIFIED TO 2004 MODEL YEAR MOTORCYCLE EMISSION STANDARDS IN CALIFORNIA.	
E-CONTROL MEETS CALIFORNIA EMISSION STANDARDS IN CALIFORNIA.	
ENGINE MODEL OR SPECIFIC DATA:	
ADJUSTABLE:	NON ADJUSTABLE
SOLE SPEED:	1400 RPM IN NEUTRAL
SOLE MILEAGE:	NON ADJUSTABLE
VALVE CLEARANCE:	0.10 - 0.16 (IN) / 0.26 - 0.28 (MM) / 0.0043 - 0.0118 (IN) / 0.11 - 0.13 (MM)
SPARK PLUG:	NGK-AR60
SPARK PLUG GAP:	0.6 mm
FUEL:	UNLEADED GASOLINE ONLY - 91 (GRADE OCTANE) OR HIGHER
Oil:	SAE 10W-50
VIN: VBKVA440X3M123456	DATE OF MANUFACTURE: 10-08-2003

[8] Before you go for the first ride

ACHTUNG
Lesen Sie vor der ersten Inbetriebnahme des Motorrades die gesamte Bedienungsanleitung aufmerksam durch!

IMPORTANT
Before you go for the first ride on your motorcycle, read the entire User's Guide carefully!

ATTENZIONE
Prima della prima messa in servizio del motorciclo, leggere attentamente l'intero manuale d'uso.

ATTENTION
Il convient de lire attentivement tout le manuel d'utilisation avant la première mise en service!

ATTENTION
Leer atentamente todas las indicaciones para el servicio antes de la primera puesta en marcha de la motocicleta.

[2] Type label CAN

VIN: VBKVA440X3M123456		
TYPE:	990	990
DISPLACEMENT	1000cc (61.03.103.000)	1000cc (61.03.103.000)
MAX. SPEED (km/h)	180	180
MAX. SPEED (mi/h)	112	112
MAX. WEIGHT (kg)	387	387
MAX. WEIGHT (lbs)	854	854
DATE OF MANUFACTURE	10-08-2003	10-08-2003
DATE OF MANUFACTURE	10-08-2003	10-08-2003

[9] Type label USA

KTM MFD. BY KTM SPORTMOTORCYCLE AG, AUSTRIA	
MOTORCYCLE	
DATE	
GVWR	387 kg
GVWR FRONT	190 kg WITH 120/70-17 TYRE, SW TYP.
	3.90-17 RIM, AT 35 psi 2.4 bar COLD
GVWR REAR	250 kg WITH 180/55-17 TYRE, F2W TYP.
	5.90-17 RIM, AT 35 psi 2.4 bar COLD
THIS VEHICLE CONFORMS TO ALL APPLICABLE U.S. FEDERAL MOTOR VEHICLE SAFETY STANDARDS IN EFFECT ON THE DATE OF MANUFACTURE SHOWN ABOVE.	
VBKVA440X3M123456	



3211249en



KTM Group Partner



KTM Sportmotorcycle AG
A-5230 Mattighofen
www.ktm.at